



Di Gilio REAC

Sistemas de Freno

CATALOGO JUNIO 2026



www.digilioreac.cl

DISTRIBUIDOR PARA CHILE



VÁLVULAS PARA SEMIREMOLQUES

4018	M16	M22	M16	971500
4045	M16	M16	M16	972800
4033	3/8"	3/8"	3/8"	996300
4019	1/4"	1/2"	1/4"	890300



4044	M16	M16	M16	981800
------	-----	-----	-----	--------

PROTECCION MAXI

PRESION DE SERVICIO 0,5 A 12 BAR

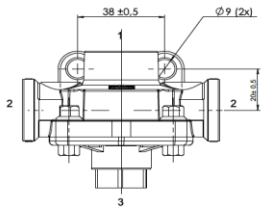

4043	VALVULA SUSPENSION MIXTA
	INCLUYE VALVULAS Y CONECTORES



4013	VALVULA NIVELADORA CON LIMITE DE ALTURA
------	--



V Á L V U L A S N I V E L A D O R A - C O M P O N E N T E S

4048 VÁLVULA NIVELADORA M12 612035011

INCLUYE VARILLA HORIZONTAL

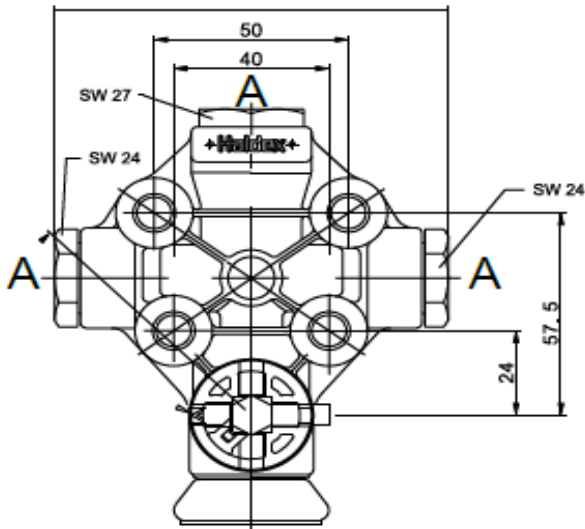

4052 VARILLA HORIZONTAL 3575709



4046 VARILLA VERTICAL 995703



4047 PUNTO FIJO PARA INSTALACIÓN 612025001



4051 REPARACIÓN DE PUNTO FIJO 998200



VÁLVULAS

4002 DRENO AUTOMATICO DDP M22



4057 FRENO DE ESTACIONAMIENTO HILO M16

980300



4049 VÁLVULA ACCIONAMIENTO FRENO DE EMERGENCIA EJE DE LEVANTE HILO M16

965900



4054 VÁLVULA ACCIONAMIENTO FRENO DE SERVICIO HILO M16

965500



4075 KIT PANEL PARA REMOLQUES CON FILTRO DE LINEA

500191



VÁLVULAS

4001 VÁLVULA DE BLOQUEO

10100

PUERTO 1 M22
2,3,12 M16

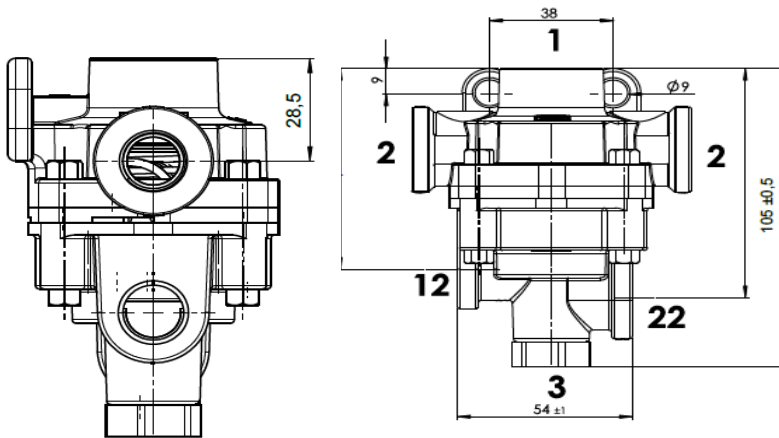

4053 VÁLVULA REGULADORA CON RETORNO M22 5.0 BAR

980500

4055 VÁLVULA REGULADORA SIN RETORNO M22 5.0 BAR

984000

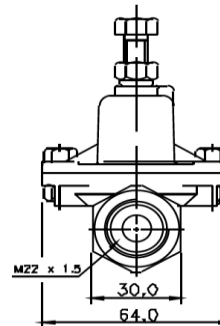

PRESION MAXIMA DE SERVICIO 12 BAR

4040 VÁLVULA TRANSFER 2 VÍAS M16

951200



PRESION MAXIMA DE SERVICIO 12 BAR

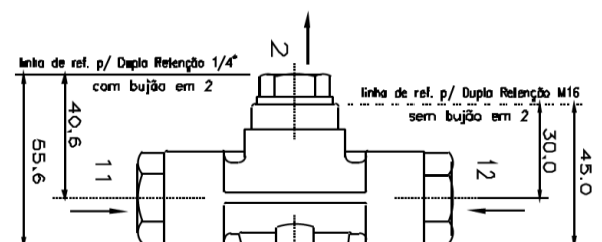

MANOS PARA ACOPLE

**4032 AUTOMATICA M16 AMARILLA
 SERVICIO**

981000

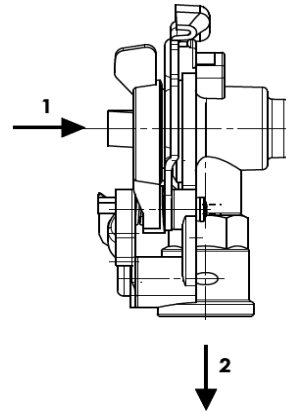

**4031 AUTOMATICA M16 ROJO
 EMERGENCIA**

980900

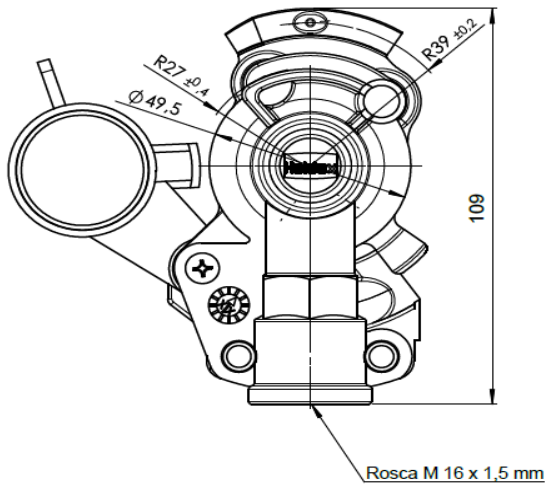

**4030 SIMPLE M16 AMARILLA
 SERVICIO**

976000

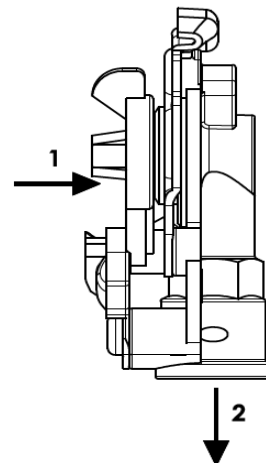

**4021 SIMPLE M16 ROJO
 EMERGENCIA**

975900



KIT VALVULA COLAS PARA SUSPENSION

1550 KIT COMPLETO VALVULA COLAS PARA SUSPENSION

INCLUYE:

**VÁLVULA COLAS CON CONEXIONES 8 mm
SELENOIDE 24V 338 071 101**

CABLE 4 M PARA VALVULA COLAS

SOPORTE PARA VALVULA

CONJUNTO DE PERNOS



**FUNCIONAMIENTO KIT VALVULA COLAS PARA
SUSPENSION NEUMATICA, REGULA ALTURA DE
SUSPENSION : EJEMPLO APLICACION PARA ANDENES DE
CARGA.**

FUNCIONAMIENTO SUBIR o BAJAR ALTURA



VALVULA DIVERSAS

3031 VALVULA DE LIBERACION REMOLQUE M16 x M22

RANGO MAXIMO DE OPERACIÓN 8,5 BAR
 WABCO ORIGINAL 9630060010



3037 VALVULA CONTROL DE REMOLQUE M16

VOLVO	3173151
VOLVO	20424431
VOLVO	8163008



3033 VALVULA SELENOIDE 24V 3/2



3029 VALVULA MANUAL DOBLE



MANOS PARA ACOPLER

7603 ACOPLER AUTOMÁTICA AMARILLA M16
SERVICIO



7604 ACOPLER AUTOMÁTICA ROJA M16
EMERGENCIA



7601 SIMPLE M16 AMARILLA
SERVICIO



7602 SIMPLE M16 ROJO
EMERGENCIA



7608 GOMA LISA PARA MANO DE ACOPLER



7606 AZUL 1/2" SERVICIO



7627 AZUL M16 SERVICIO



7607 ROJA 1/2" EMERGENCIA

7628 ROJA M16 EMERGENCIA

MANOS ACOPLE - ESPIRALES

2115 AZUL 1/2" SERVICIO



2114 ROJA 1/2" EMERGENCIA



2117 AZUL 45° 1/2" 3/8" SERVICIO



2116 ROJA 45° 3/8" EMERGENCIA



**2118 CONJUNTO ESPIRAL AZUL-ROJO
4.5 MTS HILO 1/2"**

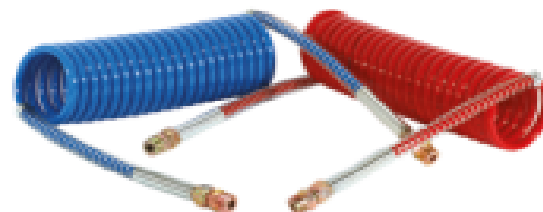

**2119 CONJUNTO ESPIRAL AZUL-ROJO
4.5 MTS HILO 1/2" y EXTENSION**

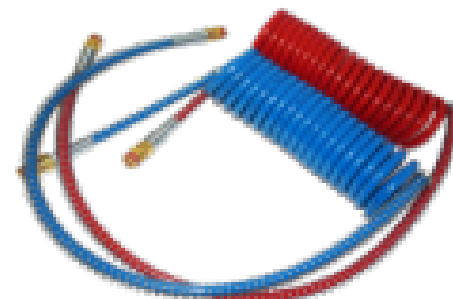

**2110 PISTOLA LIMPIEZA CABINA 3,5 MTS
1/4 INCLUYE CONECTORES**



VALVULAS PARA EQUIPOS AMERICANOS

2101 GOBERNOR D2 1/8" PRESIÓN 100 - 120 PSI



**7318 VÁLVULA PROTECCIÓN 4 CIRCUITOS
HILO M22 x 1,5 / M16 x 1,5**



**7319 VÁLVULA PROTECTORA DE PRESIÓN
HILO 1/4"**



**7311 VÁLVULA RELE CON EMERGENCIA RE 6
HILO 3/8" y 1/4"**



**2103 VÁLVULA RELE CON EMERGENCIA RE 6
HILO 3/4" y 3/8"**

PRESION MAXIMA 95 PSI

**7312 VÁLVULA RELE CON EMERGENCIA
KN 30400 HILOS 1/4" y 3/8"
3.0 PSI PRESIÓN**



**7313 VÁLVULA RELE 2 SALIDAS KN 28500
HILO 1/4" y 3/8"
5,5 PSI PRESION**



VALVULAS DIVERSAS

2106 **DESCARGA RAPIDA 3/8" x 3/8" x 3/8"**



2108 **VALVULA FF2 FULL FUCTION**



7315 **VÁLVULA NIVELADORA 1/4" COMPLETA**



7625 **KIT DE RESORTES DE FRENOS TIPO "Q" 16 1/2"**



7629 **RESORTE**



7630 **RESORTE**



VALVULAS DIVERSAS

7280 **REGULADOR DE PRESIÓN
DE 0 A 12 BAR 1/4" BSP
CON MANOMETRO**



6009 **MANO DOBLE TIPO FIAT
APLICACIÓN REMOLQUE FORESTAL**



6011 **REPARO MACHO DE ACOUPLE PARA MANO TIPO FIAT
HILO 3/8"**



6001 **VALVULA ACCIONAMIENTO HILO 1/4" NPT**



6002 **VALVULA PROTECTORA DE SOBREPRESION
HILO 1/4" NPT**



6004 **VALVULA DESCARGA EJE IZABLE
HILO 3/8" 3/8" 1/4"**



6005 **VALVULA DESCARGA EJE IZABLE
HILO M16 - M16 -M16**

VALVULAS DIVERSAS

- 6012 VALVULA ACCIONAMIENTO
SUSPENSION NEUMATICA 5 VIAS 2 POSICIONES**



- 6013 ELECTROVALVULA 24V NEUMATICA
5 VIAS 2 POSICIONES**



MEMBRANAS - CHICHARRAS MANUALES - AUTOMATICA

7624	PULMON 30/30 HILO 3/8"	
-------------	-----------------------------------	---

7623	PULMON 30 HILO 3/8"	
-------------	--------------------------------	--

7620	6"	
7621	7"	
7622	8"	

7660	CHICHARRA MANUAL 10 ESTRIAS	
-------------	------------------------------------	---

7661	CHICHARRA MANUAL 28 ESTRIAS	
-------------	------------------------------------	---

ESPIRALES PARA AIRE

5, 5 METROS

5168	M16x1,5 ROJO	BRASIL
5169	M16x1,5 AMARILLO	BRASIL
5170	1/2" ROJO 5,5 MTS	BRASIL
5171	1/2" AMARILLO 5,5 MTS	BRASIL



5211	M16 AMARILLO 5,5 MTS	BRASIL
5212	M16 ROJO 5,5 MTS	BRASIL



5131 12 mm M16 **5210** M16 M22 M16 **5211** AMARILLO
5212 ROJO

6, 5 METROS

5172	M16x1,5 ROJO	BRASIL
5173	M16x1,5 AMARILLO	BRASIL
5174	1/2" ROJO	BRASIL
5175	1/2" AMARILLO	BRASIL



ESPIRAL M16

7610	M16x1,5 AMARILLO	CHINA
7611	M16x1,5 ROJO	CHINA
7612	1/2" ROJO	CHINA
7613	1/2" AMARILLO	CHINA



TECALAN - HERRAMIENTA CORTA TECALAN

LIMPIA CABINA

5167 ESPIRAL CON PISTOLA /
LIMPIAR CABINA HILO 1/4"



TECALAN mm

ROLLOS

5176	4 x 1 mm	50 - 25	MTS
5177	6 x 1 mm	50 - 25	MTS
5178	8 x 1 mm	50 - 25	MTS
5179	10 x 1,5 mm	50 - 25	MTS
5181	12 x 1,5 mm	50 - 25	MTS
5182	14x 2 mm	50 - 25	MTS
5183	15 x 1,5 mm	50 - 25	MTS
5185	16 x 2 mm	50 - 25	MTS



TECALAN PULGADA

ROLLOS

5186	1/8"	50 - 25	MTS
5187	1/4"	50 - 25	MTS
5188	3/8"	50 - 25	MTS
5189	1/2"	50 - 25	MTS
5184	5/8"	50 - 25	MTS



ALICATE PARA CORTAR TECALAN - REPUESTO

5066 ALICATE
5067 REPUESTO



UNIONES ACOPLÉ RÁPIDO mm - PULGADAS

	TUBO	TUBO
5230	6 mm	6 mm
5232	8 mm	8 mm
5234	10 mm	10 mm
5236	12 mm	12 mm
5237	14 mm	14 mm
5238	15 mm	15 mm
5239	16 mm	16 mm
5240	1/4"	1/4"
5241	3/8"	3/8"
5242	1/2"	1/2"



REDUCCIONES

5224	8 mm	6 mm
5226	10 mm	8 mm
5227	12 mm	8 mm
5228	12 mm	10 mm
5229	16 mm	12 mm



UNION MACHO

	TUBO	HILO
5274	6 mm	M12
5275	6 mm	M16
5124	8 mm	M12
5125	8 mm	M16
5126	8 mm	M22
5278	8 mm	1/4"
5279	8 mm	3/8"
5127	10 mm	M12
5128	10 mm	M16
5129	10 mm	M22
5130	12 mm	M12
5131	12 mm	M16
5132	12 mm	M22
5123	12 mm	3/8"
5134	16 mm	M16
5135	16 mm	M22



UNION ACOPLÉ RÁPIDO PULGADA - mm

	TUBO	HILO
5293	1/4"	M12
5270	1/4"	M16
5273	1/4"	1/4"
5266	3/8"	M16
5267	3/8"	M22
5272	3/8"	1/4"
5271	3/8"	3/8"
5268	1/2"	M16
5291	1/2"	3/8"
5292	1/2"	1/2"
5269	1/2"	M22



CODO MACHO mm

	TUBO	HILO
5282	6 mm	M12
5138	8 mm	M16
5350	8 mm	M12
5139	8 mm	M22
5140	10 mm	M16
5141	10 mm	M22
5143	12 mm	M16
5144	12 mm	M22
5146	16 mm	M22



CODO MACHO PULGADA

	TUBO	HILO
5149	3/8"	1/4"
5145	3/8"	3/8"
5148	1/4"	1/4"
5288	1/4"	M12
5264	1/4"	M16
5265	3/8"	M16



CODOS ACOPLÉ RÁPIDO mm - PULGADA

	TUBO	HILO
5262	1/2"	M16
5263	1/2"	M22
5286	1/2"	3/8"
5287	1/2"	1/2"
5261	5/8"	1/2"



T ACOPLÉ RAPIDO

	TUBO	TUBO	TUBO
5217	6 mm	6 mm	6 mm
5150	8 mm	8 mm	8 mm
5218	10 mm	10 mm	10 mm
5219	12 mm	12 mm	12 mm
5220	16 mm	16 mm	16 mm







T ACOPLÉ RAPIDO

	TUBO	HILO	TUBO
5256	6 mm	M16	6 mm
5257	8 mm	M16	8 mm
5258	10 mm	M16	10 mm
5153	12 mm	M16	12 mm
5154	12 mm	M22	12 mm



PASA MUROS mm - PULGADA

PASAMUROS

	TUBO		HILO	
5120	8 mm		M16	
5121	10 mm		M16	
5122	12 mm		M16	
	TUBO		HILO	
5137	12 mm	x	3/8"	
5142	10 mm	x	M16	
5136	1/2"	x	1/4"	
5207	1/4"	x	M22	

HERRAMIENTA Y CONECTORES SISTEMA D.O.T

**HERRAMIENTA PARA DESCONECTAR TECALAN
 CAMIONES VOLVO Y SCANIA - CONECTORES SISTEMA RAUFFOS**

	TUBO
5108	6 mm
5109	8 mm
5110	10 mm
5111	12 mm
5112	16 mm



	TUBO		HILO
5100	8 mm	x	M16
5103	8 mm	x	M22
5101	10 mm	x	M16
5104	10 mm	x	M22
5105	12 mm	x	M22
5106	16 mm	x	M22



SET HERRAMIENTAS PLASTICAS / RAUFFOS

5099	6 mm
	8 mm
	10 mm
	12 mm
	14 mm
	15 mm
	16 mm



CONECTORES DIVERSOS

ACOPLE RAPIDO CON ANILLO DE SEGURIDAD

5200	PINO M16
5201	ACOPLE RAPIDO M16 COMPLETO
5209	ACOPLE RAPIDO 3/8" COMPLETO
5202	ACOPLE RAPIDO 1/2" COMPLETO



ACOPLE RAPIDO PARA LINEA DE AIRE - TALLER

5095	ACOPLE RAPIDO 1/4" HEMBRA
5098	ACOPLE PINO 1/4"



UNIONES DIVERSAS

	HILO		HILO
5216	M16	x	M16
5133	1/4"	x	1/4"
5206	1/4"	x	3/8"
5214	3/8"	x	3/8"
5215	1/2"	x	1/2"



CODO

5352	3/4"	x	3/4"
5048	1/4"	x	1/4"



CRUZ

5195	M16	M16	M16	M16
				25



UNIONES - T

	HEMBRA	HEMBRA	HILO
5047	M16	M16	M16
5049	3/8"	3/8"	3/8"



T HILO INTERIOR

5053	M16	M16	M16
5055	1/4"	1/4"	1/4"



	HEMBRA	HILO	HEMBRA
5194	3/8"	M22	3/8"



UNION HILO INTERIO

5051	M16	x	M16
5223	1/8"	x	1/8"
5199	1/4"	x	1/4"
5221	3/8"	x	3/8"
5222	1/2"	x	1/2"



UNION HILO MACHO

5050	M22	x	M22	
5198	M16	x	M16	
5225	M22	x	M22	ACERO



ADAPTADORES - REDUCCIONES

	HEMBRA		MACHO	
5159	M16	x	M22	
5161	M16	x	1/4"	
5163	M16	x	3/8"	
5152	M22	x	M16	
5164	M22	x	3/8"	
5116	M22	x	1/2"	
5162	1/4"	x	M12	
5196	3/8"	x	M16	
5166	1/2"	x	M16	
5160	1/2"	x	M22	
5165	1/2"	x	3/8"	
5197	3/4" NPT	x	M22	



ADAPTADORES

	HEMBRA		MACHO	
5193	M12	x	3/8"	
5156	M16	x	1/2"	
5158	M16	x	3/4"	
5155	M22	x	1/2"	
5157	M22	x	3/4"	
5205	1/8"	x	3/4"	
5192	1/4"	x	M16	
5191	1/4"	x	M22	
5351	1/4"	x	1/2"	
5190	1/4"	x	3/4"	
5204	3/8"	x	M22	
5203	3/8"	x	1/2"	



LLAVES DE DRENO - TAPONES - TOMA DE PRUEBA

HILO

5054

1/8"

5057

1/4"



SILENCIADORES

5249

1/8"



5250

1/4"



VALVULA DRENO

5059

M22



5259

CONECTOR M16 GIRATORIO
MANGUERA 5/16" 5260



5260

TOMA DE PRUEBA M16



TAPONES

5000

ACERO

M12

5089

M14

5002

M16

5058

ACERO

M22

5005

BRONCE

1/8"

5079

BRONCE

1/4"



5001

BRONCE

3/8"

5068

BRONCE

1/2"

5064

BRONCE

3/4"



CODOS INCLUYE CONO

	TUBO	HILO
5078	1/8"	1/8"
5006	1/8"	1/4"
5003	1/4"	1/8"
5004	1/4"	1/4"
5069	1/4"	3/8"
5284	1/4"	M16
5009	3/8"	1/8"
5007	3/8"	1/4"
5008	3/8"	3/8"
5074	3/8"	1/2"
5017	1/2"	1/4"
5076	1/2"	3/8"
5077	1/2"	1/2"
5254	5/8"	3/8"
5255	5/8"	1/2"



CODOS

	TUBO	HILO
5021	6 mm	1/4"
5056	8 mm	1/8"
5018	8 mm	1/4"
5022	10 mm	1/4"
5070	10 mm	3/8"
5071	10 mm	1/2"
5019	12 mm	1/4"
5020	12 mm	3/8"
5075	12 mm	1/2"
5024	12 mm	M16



UNIONES INCLUYE CONO

	TUBO	HILO
5011	1/8"	1/8"
5013	1/8"	1/4"
5012	1/4"	1/8"
5010	1/4"	1/4"
5015	1/4"	3/8"
5072	3/8"	1/4"
5073	3/8"	3/8"
5063	3/8"	1/2"
5251	1/2"	1/4"
5061	1/2"	3/8"
5062	1/2"	1/2"
5252	5/8"	3/8"
5253	5/8"	1/2"
5353	1/4"	



NUEVO PRODUCTO



CODOS

5093	6 mm	1/8"
5094	6 mm	1/4"
5096	8 mm	1/8"
5097	8 mm	1/4"
5023	10 mm	3/8"
5014	12 mm	1/4"
5016	12 mm	3/8"



TUERCA

5354	8 mm
5355	12 mm

NUEVO PRODUCTO



UNIONES INCLUYE CONOS

	TUBO	HILO
5025	4 mm	4 mm
5080	6 mm	6 mm
5026	8 mm	8 mm
5081	10 mm	10 mm
5027	12 mm	12 mm
5086	1/8"	1/8"
5087	1/4"	1/4"
5028	3/8"	3/8"
5029	1/2"	1/2"
5248	5/8"	5/8"



T - INCLUYE CONOS

	TUBO	HILO	TUBO
5060	1/4"	1/4"	1/4"
	TUBO	TUBO	TUBO
5082	1/8"	1/8"	1/8"
5083	1/4"	1/4"	1/4"
5084	3/8"	3/8"	3/8"
5085	1/2"	1/2"	1/2"
5088	6 mm	6 mm	6 mm
5065	8 mm	8 mm	8 mm
5052	12 mm	12 mm	12 mm



CONOS INSERTOS mm - PULGADA

INSERTOS

5032	4 mm
5033	6 mm
5034	8 mm
5036	10 mm
5035	12 mm
5092	15 mm
5041	16 mm
5090	1/8"
5030	1/4"
5031	3/8"
5091	1/2"
5246	3/4"
5247	5/8"



CONOS

5037	1/8"
5038	1/4"
5039	3/8"
5040	1/2"
5243	3/4"
5244	5/8"
5245	5/16"
5042	6 mm
5043	8 mm
5044	10 mm
5045	12 mm
5046	16 mm



UNIONES PARA MANGUERA

	TUBO	TUBO
5301	6 mm	6 mm
5302	8 mm	8 mm
5303	10 mm	10 mm
5304	12 mm	12 mm
5305	16 mm	16 mm
5307	1/4"	1/4"
5308	3/8"	3/8"
5309	1/2"	1/2"
5310	3/4"	3/4"



UNION RECTA

	TUBO	HILO
5317	1/4"	1/8"
5318	1/4"	1/4"
5322	1/4"	3/8"
5323	3/8"	1/4"
5319	3/8"	3/8"
5320	3/8"	1/2"
5324	1/2"	1/4"
5325	1/2"	3/8"
5321	1/2"	1/2"



UNION RECTA HILO INTERIOR

	TUBO	HILO I
5300	1/4"	1/8"
5306	1/4"	1/4"
5311	1/4"	3/8"
5312	3/8"	1/4"
5313	3/8"	3/8"
5314	3/8"	1/2"
5315	1/2"	1/4"
5316	1/2"	3/8"



UNIONES PARA MANGUERA

	TUBO	HILO	TUBO
5340	1/4"	1/4"	1/4"
5342	1/2"	1/2"	1/2"
5343	3/16"	3/16"	3/16"
5344	5/16"	5/16"	5/16"



CONECTORES PARA MBB y VW

5330 UNION TUBO 12 x 1,5 x NG12



5331 TUERCA M22 x 1,5 x NG12
 MBB A 000 997 0934
 VW 2TA 608 703 B



5333 CODO TUBO 12 x 1,5 x NG12
 MBB A 002 990 5871
 VW 2VC 608719C



5332 1 KIT DE REPARO NG12



UNIONES ACOPLÉ RÁPIDO (mm PULGADAS)

	TUBO	TUBO
7001	4 mm	4 mm
7002	6 mm	6 mm
7003	8 mm	8 mm
7004	10 mm	10 mm
7005	12 mm	12 mm
7006	14 mm	14 mm
7008	16 mm	16 mm
7009	1/4"	1/4"
7010	3/8"	3/8"
7011	1/2"	1/2"



REDUCCIONES

	TUBO	TUBO
7020	4 mm	6 mm
7021	8 mm	6 mm
7023	10 mm	8 mm
7024	12 mm	10 mm



T mm - PULGADA

7040	4 mm	4 mm	4 mm
7041	6 mm	6 mm	6 mm
7042	8 mm	8 mm	8 mm
7043	10 mm	10 mm	10 mm
7044	12 mm	12 mm	12 mm
7046	16 mm	16 mm	16 mm
7047	1/4"	1/4"	1/4"
7048	3/8"	3/8"	3/8"
7049	1/2"	1/2"	1/2"



T - REDUCCION

7050	8 mm	6 mm	8 mm
7051	6 mm	8 mm	6 mm



CODOS ACOPLA RAPIDO

	TUBO	HILO	
7060	4 mm	1/8"	
7061	6 mm	1/8"	
7062	6 mm	1/4"	
7063	8 mm	1/8"	
7064	8 mm	1/4"	
7065	8 mm	3/8"	
7059	10 mm	1/8"	
7066	10 mm	1/4"	
7067	10 mm	3/8"	
7070	12 mm	1/4"	
7068	12 mm	3/8"	
7069	12 mm	1/2"	
	TUBO	HILO	
7080	1/4"	1/8"	
7081	1/4"	1/4"	
7082	1/4"	3/8"	
7083	3/8"	1/8"	
7084	3/8"	1/4"	
7085	3/8"	3/8"	
7086	1/2"	1/4"	
7087	1/2"	3/8"	
	TUBO	TUBO	
7032	8 mm	8 mm	
7286	10 mm	10 mm	
7287	12 mm	12 mm	

UNION MACHO

	TUBO	HILO
7089	4 mm	1/8"
7090	4 mm	1/4"
7091	6 mm	1/8"
7092	6 mm	1/4"
7093	6 mm	3/8"
7094	8 mm	1/8"
7095	8 mm	1/4"
7096	8 mm	3/8"
7113	8 mm	1/2"
7103	10 mm	1/8"
7097	10 mm	1/4"
7098	10 mm	3/8"
7099	10 mm	1/2"
7100	12 mm	1/4"
7101	12 mm	3/8"
7102	12 mm	1/2"
7105	1/4"	1/8"
7104	1/4"	1/4"
7000	1/4"	3/8"
7106	3/8"	1/8"
7107	3/8"	1/4"
7108	3/8"	3/8"
7109	1/2"	1/4"
7110	1/2"	3/8"
7111	1/2"	1/2"



FOCOS LATERALES EQUIPOS BRASIL

FOCOS LATERAL

8622 AMBAR MV 6,5 CM MV

INCLUYE BASE Y ENCHUFE



**Multi
Volt**



8623 ROJO MV 6,5 CM MV



FOCOS CON BASE INCLUIDA

8627 AMBAR 6,5 CM MV DIAMETRO CON BASE

**Multi
Volt**



8628 ROJO 6,5 CM MV DIAMETRO CON BASE



MODULOS - FOCO PATENTE

8643

REPARO IZQ / DER



Multi Volt



8640

REPARO IZQ / DER



8646

DERECHO



8647

IZQUIERDO

INCLUYE REFLECTANTE



8641

IZQUIERDO

8642

DERECHO

MODULO CON INTERMITENTE SECUENCIAL

8635

5 VIAS



8655

DERECHO

8656

IZQUIERDO



8657

CABLE Y PARA MODULO 8655-8656



8635

5 VIAS

8639

CONTROL LED DCL FLASHER 12/24V



8632

2 VIAS CONSIDERAR 2 UNIDADES



MODULO TRASERO INTERMITENTE SECUENCIAL

8666 DERECHO

8667 IZQUIERDO

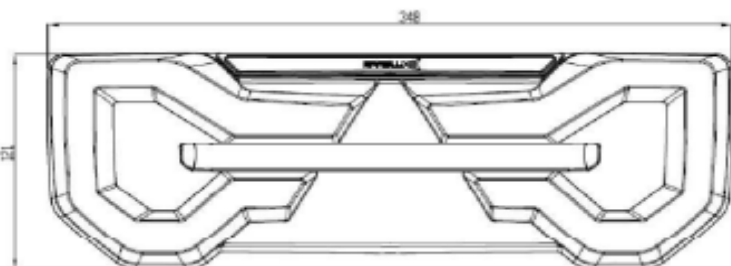

8651 DERECHO

8652 IZQUIERDO



7 PINES

8644 DERECHO

8645 IZQUIERDO



-40° a 55°C



Homologado



Patenteado



IP6K9K

MODULO TRASERO

8671 DERECHO

8672 IZQUIERDO

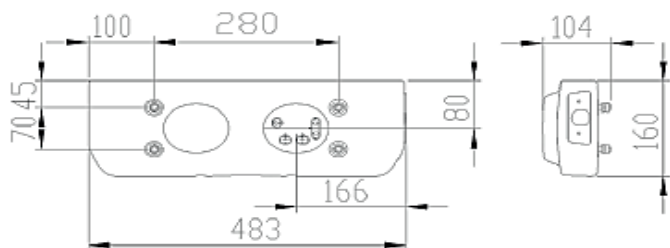

ACESORIOS - LUZ PARA PATENTE

8670 CAJA PARA HERRAMIENTAS
 690 x 530 x 550 / PESO 7 KILOS
 CON CHAPA / 2 LLAVES



SOPORTE - INCLUYE FOCO

8669 SOPORTE PARA PATENTE INCLUYE FOCO **8606**

8632 2 VIAS (CONSIDERAR)



FOCOS PARA PATENTE CON ENCHUFE

8608 FOCO PATENTE

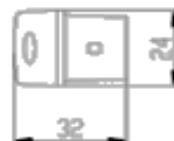
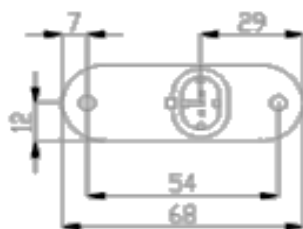

8632 2 VIAS



8606 FOCO PATENTE

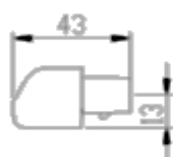
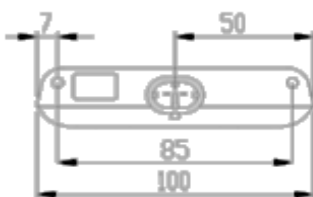

8632 2 VIAS



8607 FOCO PATENTE
 UNIVERSAL 4 LED C/ CABLE

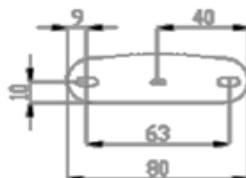

ENCHUFES - PLAFON

ENCHUFES - SOQUETES

8632	2 VIAS
8633	3 VIAS
8634	4 VIAS
8635	5 VIAS



5 PINES

8636	DERECHO
8637	IZQUIERDO



PLAFON

8616 PLAFÓN MV SISTEMA ON / OF TOUCH

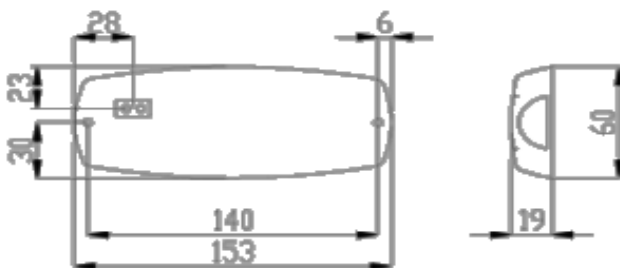

Multi Volt



8617 PLAFÓN SLIM MV SISTEMA ON / OF TOUCH
 155 mm x 13 mm



8618 PLAFÓN SLIM MV



8619 INTERRUPTOR 2 CONTACTOS



FOCOS ESPECIALES

8631 VIRAJE AMPLIO

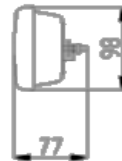
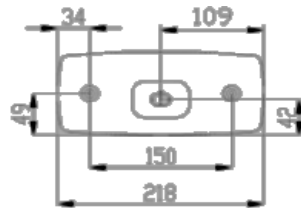

8632 ENCHUFE



8620 DERECHO

8621 IZQUIERDO

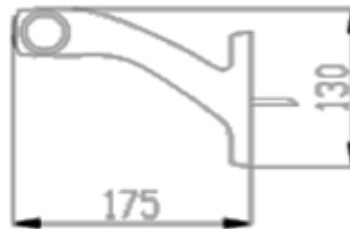

LUZ BLANCA / ÁMBAR / ROJA

FOCO FIN DE LINEA LUZ BLANCA/ROJA

8629 FOCO FIN DE LINEA MV

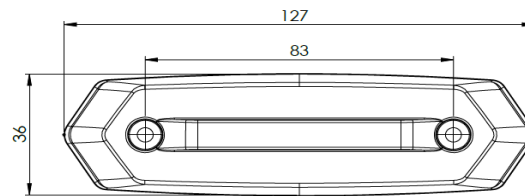

FOCO ANTINEBLA - SOPORTE

8684 FOCO ANTI NIEBLA 12/24V
 CON SOPORTE



8632 ENCHUFE



8685 SOPORTE

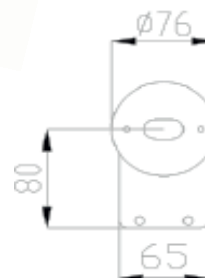

2" / 4" MV CON ARO DE GOMA / SOPORTE

8653 2" AMBAR



8654 2" ROJO



8632 ENCHUFE



4" MV CON ARO DE GOMA

8648 4" ROJO



8649 4" AMBAR



8650 4" BLANCO



8633 3 VIAS



4" MV CON ARO DE GOMA

8072 BASE PARA FOCO 4"



FOCOS PARA REMOLQUE

FOCO PARA EQUIPOS GUERRA

8692 AMBAR

Multi Volt



8693 ROJO



8694 BLANCO



8632 ENCHUFE



FOCOS

8663 AMBAR

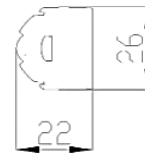
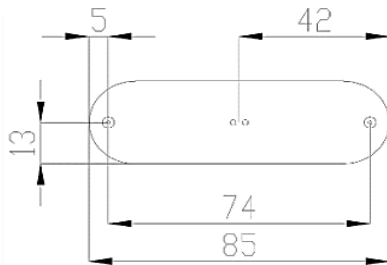

8664 ROJO



8665 BLANCO



Multi Volt



FOCOS LATERALES

8605 AMBAR 2 CONTACTOS



8615 AMBAR BLANCO 2 CONTACTOS



8676 BLANCO



8677 AMBAR



8678 ROJO TROCHA



FOCO FAENEROS

8658 FAENERO 12 LED 6W 900 LUMENS

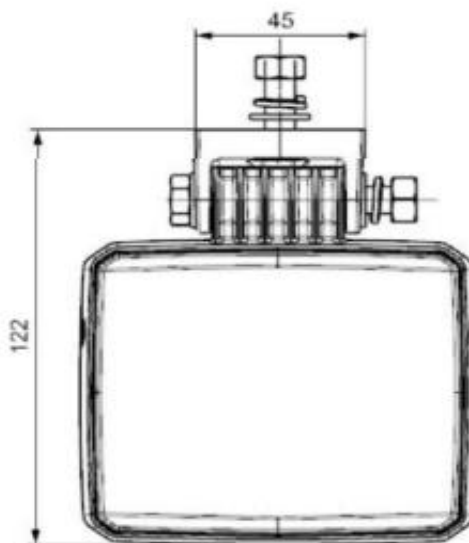
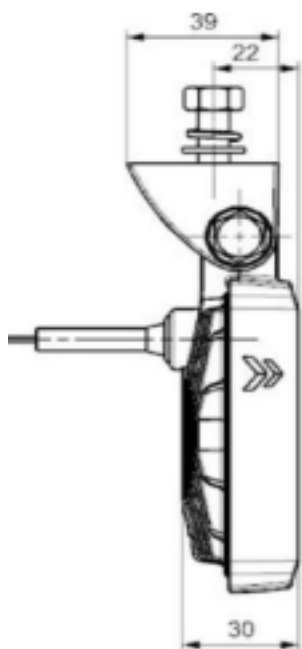

-40 a 50 °C



IP6K7
IP6K9K

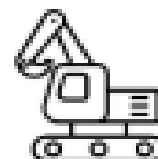

FOCO DE SEGURIDAD



**8686 FOCO SEGURIDAD RED LINE
 48V 10W**

INCLUYE ENCHUFE



8632 ENCHUFE (NO INCLUIDO)



RED LINE



EMC R10
 CISPR25/classe 3

IP IP6K9K

UV 1500h
 -40 á 85°C

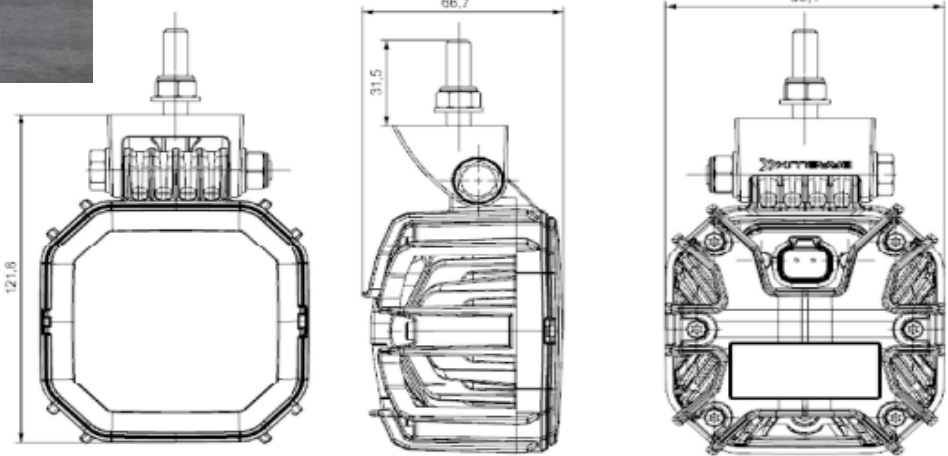

MODULO TRASERO FACCHINI - LATERALES

MODULO TRASERO FACCHINI

6570 DERECHO
 CON ANTINEBLA



Multi Volt

6571 IZQUIERDO



NUEVO PRODUCTO

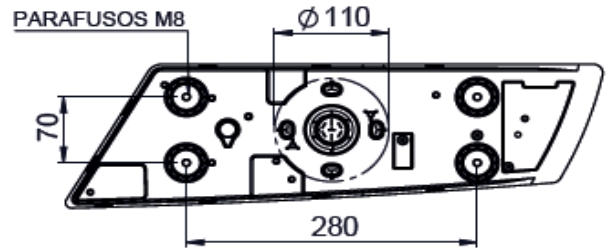
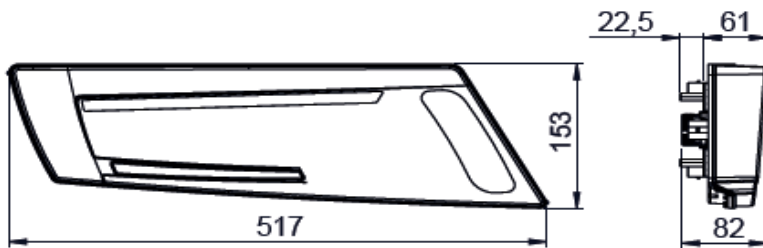

6572 CONECTOR LADO DERECHO



6573 CONECTOR LADO IZQUIERDO



6574 CONTROL LED / FLASCH
 FACCHINI



NUEVO PRODUCTO

6575 CONTROL LED / FLASCH
 UNIVERSAL

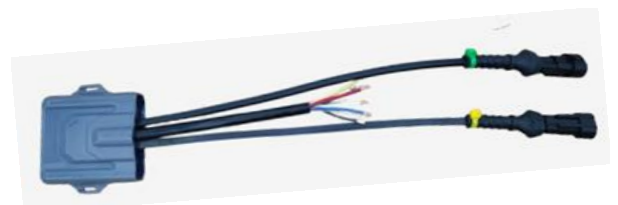

FOCOS - LATERALES

FOCOS LATERALES

6581 AMBAR SIN SOPORTE C/CABLE



**Multi
Volt**

6582 AMBAR CON SOPORTE C/ CABLE



6583 ROJO C/ CABLE



**Multi
Volt**

6584 BLANCO C/ CABLE



6585 VERDE



FOCO PATENTE

6580 PATENTE



SISTEMA DOWN LIGHT

ILUMINACION LATERAL Y AL PISO MAYOR SEGURIDAD

SIDELIGHT

Conta com tecnologia **DOWNLIGHT**

Conta com tecnologia **DOWNLIGHT**

MAIS SEGURANÇA E VISIBILIDADE
 para seu implemento

DISPONIBLE SOLO PARA FOCOS AMBAR

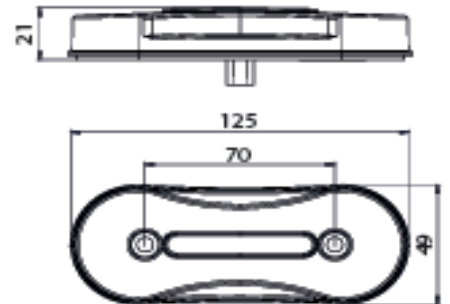

FOCOS TROCHA LED

FOCOS 1 DIODO

8000 **ÁMBAR DIÁMETRO 3/4"**

**Multi
Volt**



8001 **ROJO DIÁMETRO 3/4"**

**1
diode**



**PRODUCTO 100% SELLADO
100.000 HORAS DE GARANTIA**

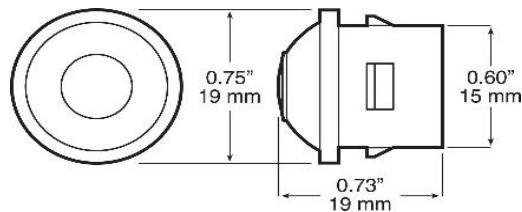

FOCOS 2 DIODOS

8008 **ÁMBAR 2 DIODOS**

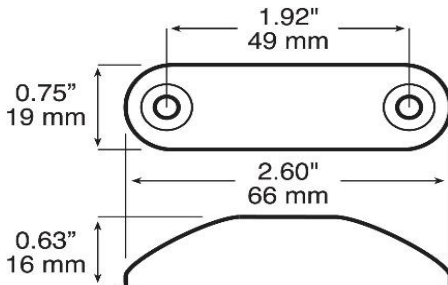

8009 **ROJO 2 DIODOS**



**Multi
Volt**

8007 **BASE PLÁSTICA**

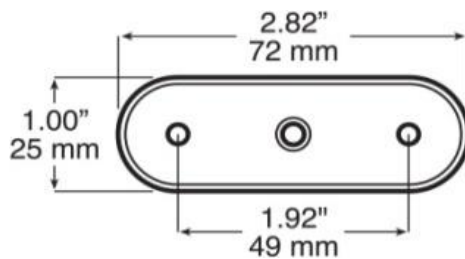

FOCOS LATERALES - LED

FOCOS 3 DIODOS

8012 ÁMBAR 3 DIODOS

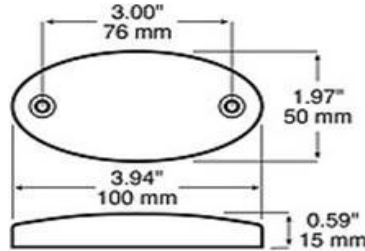

8013 ROJO 3 DIODOS



8014 ÁMBAR 3 DIODOS/REFLECTANTE MV

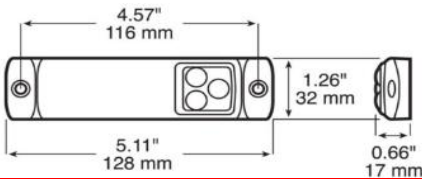

FOCOS 4 DIODOS

8010 AMBAR

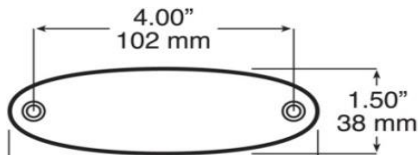

8011 ROJO



2 1/2" CON BASE PARA APERNAR

8049 AMBAR



8050 ROJO



FOCOS 4" INCLUYE ENCHUFE

CON BASE PARA APERNAR

8075 FOCO ROJO 9 DIODOS



8076 FOCO ROJO 9 DIODOS



8077 BLANCO 9 DIODOS



8072 BASE PARA FOCO 4"



PLAFON

8028 PLAFÓN 9 DIODOS

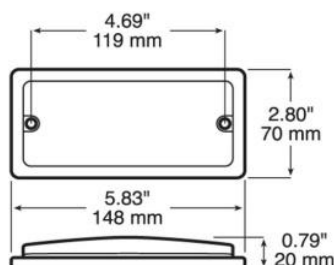

FOCO OVALADO COMPLETO

FLECHA SECUENCIAL

8071 **ÁMBAR CON BASE / FLECHA SECUENCIAL MV
ENCHUFE INCOPORADO**

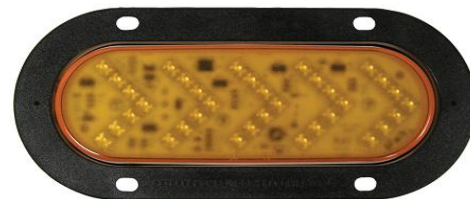

8081 **ÁMBAR 4 10 DIODOS CON ENCHUFE**

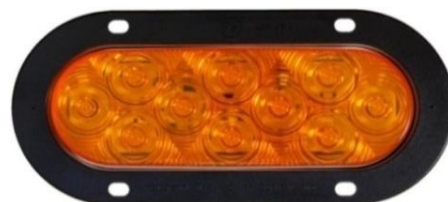

8079 **ROJO 10 DIODOS CON ENCHUFE**



FOCO OVALADO COMPLETO-ENCHUFE Y BASE

8082 **ROJO 12 - 24V 10 DIODOS**



8083 **AMBAR 12 - 24V 10 DIODOS**

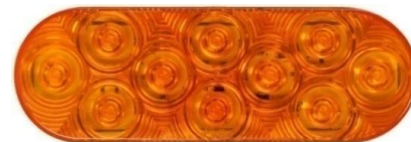

8084 **BLANCO 12 - 24V 10 DIODOS**

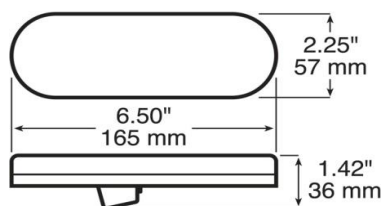

FOCO OVALADO COMPLETO STROBE

CONSIDERAR ENCHUFE

8095 BLANCO STROBE



8096 AMBAR STROBE



8097 ROJO STROBE



8633 3 VIAS



8085 SOPORTE METALICO



FOCO OVALADO COMPLETO STROBE

8046 LED 6 DIODOS ÁMBAR STROBOSCOPICO MV
 23 FUNCIONES DIFERENTES

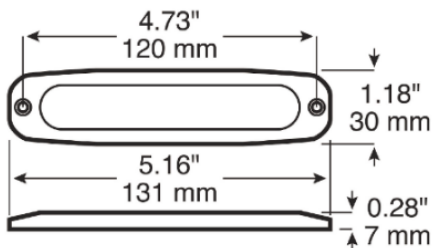

ALARMAS DE RETROCESO

8070 97 DB U.S.A. 12A 24V
USO EN CAMIONES Y VEHÍCULOS MENORES



8025 FAENERO CON INTERRUPTOR MV 450 LUMENS
ESPECIAL PARA ESTANQUES DE COMBUSTIBLE



LED WORK LIGHTS

100.000 HORAS GARANTIA

8023 4 DIODOS 700 LUMENS MV DISTANCIA 70MTS 9/36V

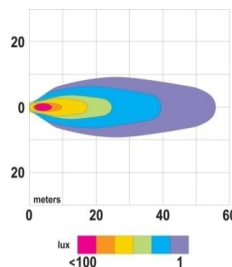
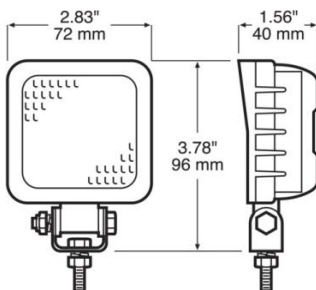

FOCOS FAENEROS

FAENEROS 3 MODELOS

7400 FOCO FAENERO LED MV 16 DIODOS 27W
108 x 50 mm



7401 FOCO FAENERO LED MV 9 DIODOS 24W
108 x 50 mm



7402 FOCO FAENERO LED MV 9 DIODOS 24W
110 x 124 mm x 53 mm



FOCOS DIVERSOS

LED LATERALES - POSICION

- 7410** AMBAR 1 DIODO
- 7411** ROJO 1 DIODO
- 7416** AMBAR 2 DIODOS
- 7417** ROJO 2 DIODOS
- 7418** BLANCO 2 DIODOS
- 7419** VERDE 2 DIODOS



LED LATERALES - POSICION

- 7423** AMBAR 12 DIODOS 12/24V
PROTECCION METAL
- 7424** ROJO 12 DIODOS 12/24V
PROTECCION METAL
- 7425** ROJO 12 DIODOS 12/24V
PROTECCION METAL



FOCOS DIVERSOS

7420 FOCO PATENTE MV

PACK
2 unidades

Multi Volt



6 DIODOS

7426 AMBAR



7427 ROJO

Multi Volt



7428 BLANCO



7434 AMBAR

PACK
4 unidades

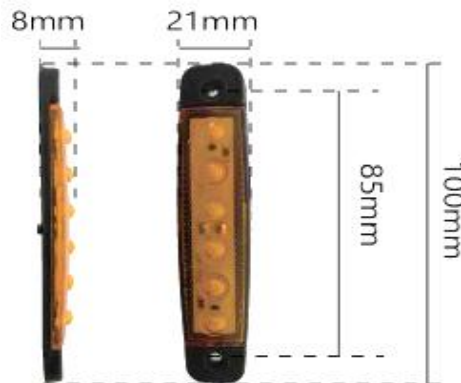

7435 ROJO



FOCOS 2" - 2 1/2"

2"

7470

AMBAR

INCLUYE ENCHUFE



7471

ROJO



2 1/2"

7472

AMBAR

INCLUYE ENCHUFE



7473

ROJO



7474

BLANCO



7469

ENCHUFE 2 CONTACTOS



FOCOS

4"

7475

AMBAR

INCLUYE ENCHUFE



7476

ROJO

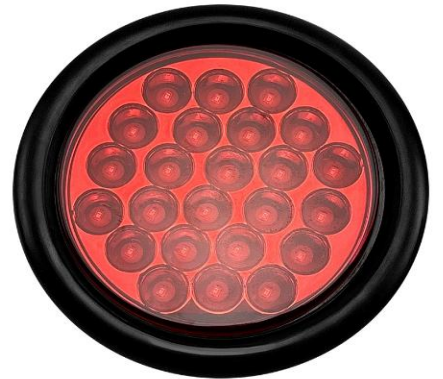

7477

BLANCO



7468

ENCHUFE 3 CONTACTOS



BASES PARA FOCOS

7478

2"



7479

2 1/2"



7480

4"



7481

OVALADO



FOCOS DIVERSOS

7430 ROJO / AMBAR

FUNCION ADICIONAL ESTROBOSCOPICO

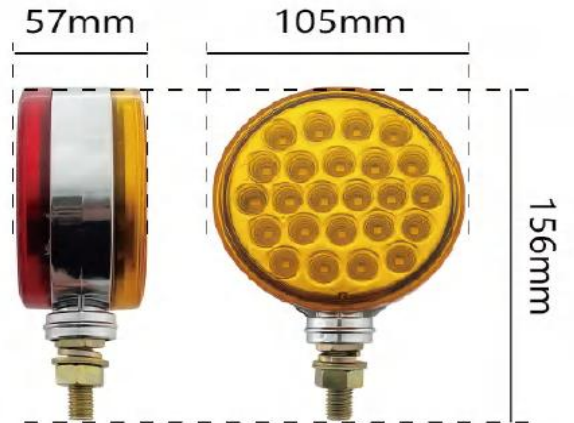

LED ESTROBOSCOPICO - VARIAS FUNCIONES

6 LED

7440 AMBAR

7441 ROJO

7442 AZUL

7443 BLANCO

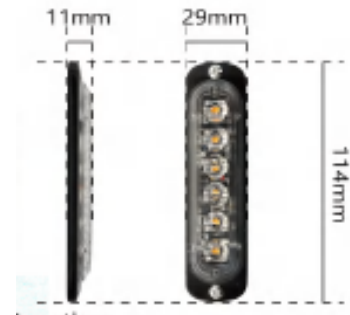

12 LED

7450 AMBAR

7451 ROJO

7452 AZUL

7453 BLANCO

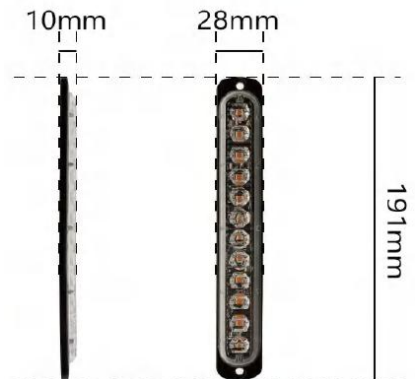

4 LED

7455 AMBAR



FOCOS PARA CAMIONES

FOCO TRASERO PARA VOLVO

- 7460** DERECHO
- 7461** IZQUIERDO



FOCO TRASERO PARA SCANIA

- 7462** DERECHO
- 7463** IZQUIERDO



- 7459** CONECTOR PARA FOCO VOLVO Y SCANIA



FOCO TRASERO PARA MBB ACTROS

- 7465** DERECHO
- 7466** IZQUIERDO



PANEL LED

DIFERENTES FUNCIONES

7510 LED PANEL

192X1762mm LED Matrix Panel

MULTIPLES FUNCIONES

TEXTO

DISEÑOS PREDETERMINADOS

USO INTERIOR / EXTERIOR



INCLUYE

CONTROL REMOTO

CABLE USB

DESCARGAR APLICACIÓN PARA USO

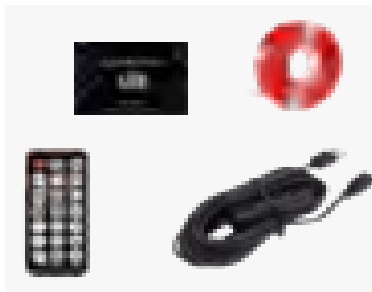

ALARMA DE RETOCESO

7500 12 A 48V 107 DB



LINTERNAS DE TRABAJO

ANTIPARRA CON LUZ SUPERIOR Y LATERAL

1130 ANTIPARRA

BRILLO MAXIMO 250 LM (MAX)
MATERIAL ABS + PVC
LENTE PLASTICO PROTECCION VISTA
MEDIDAS : 170 x 170 x 70 mm PESO 94G
BATERIA 3.7V 500mAh*2 POLYMER LI-ion
TIEMPO DE CARGA 3,5 HORAS
TIEMPO USO 4 HRS **BRILLO MEDIO**
TIEMPO USO 3 HRS **BRILLO MAXIMO**

CABLE USB Y TIPO C PARA RECARGAR



PRODUCTO CONSIDERADO DE SEGURIDAD

FUNCIONES

SENSOR A DISTANCIA PARA ENCENDER Y APAGAR
LUZ SUPERIOR
LUZ LATERAL
LUZ DE EMERGENCIA (STROBE)



LINTERNAS DE TRABAJO

CINTILLO MULTIFUNCION

1138 CINTILLO MULTIFUNCION

BRILLO MAXIMO 350 LM (MAX)
 MATERIAL SILICA GEL + ABS
 LED 3W / 5W LUZ LATERAL
 MEDIDAS : 32 x 30 x 300 mm PESO 83,5 g
 BATERIA 3.7V 102540 1.200mAh LI-ION POLYMER BATTERY
 WATERPROOF IPX4
 TIEMPO DE CARGA 3 HORAS
 TIEMPO USO **6 HRS BRILLO MEDIO**
 TIEMPO USO **4 HRS BRILLO MAXIMO**



CABLE USB / TIPO C PARA RECARGAR



FUNCIONES

INDICADOR DE CAPACIDAD DE CARGA
 SENSOR A DISTANCIA PARA ENCENDER Y APAGA
 LUZ SUPERIOR
 LUZ LATERAL
 LUZ DE EMERGENCIA (STROBE)



LINTERNAS DE TRABAJO

LINTERNA CON IMAN

1140 LINTERNA

BRILLO MAXIMO 1.000 LM (MAX)

MATERIAL ABS + PC

LED 4 W / 10W

BATERIA 3.7V 2.600 mAh-ion

LUZ FRONTAL 3 INTENSIDADES

TIEMPO DE CARGA 4 HORAS CON INDICADOR DE CARGA

TIEMPO USO **3 HRS BRILLO MEDIO**

TIEMPO USO **2 HRS BRILLO MAXIMO**

IMAN EN LA BASE / CARA PODTERIOR



IP65, IK07

MEDIDAS 268 x 61 x 42 mm PESO 339 g

CABLE USB / TIPO C PARA RECARGAR



1000
lumens
COB LED



REFLECTANTE PARA CARROCERIAS

BICOLOR NORMA DOT-C2

**1118 REFLECTANTE BI COLOR
ROLLO 47,5 MTS**

**NUEVO
PRODUCTO**



REFLECTANTE PARA CARROCERIAS

CERTIFICAION DOT-C2

Report No.: 181207-02B

TEST DATA SHEET

Project Name: 1 RT3400 W&R 6" Red / 6" White
DOT-C2 Conspicuity Trim

7.3 Daytime Color and Luminance

Requirement: ASTM D4956-90 Tables 8 and 10 (Type V Sheeting)

LIGHTING TECHNOLOGY

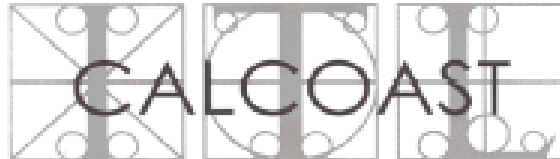

PHOTOMETRIC TESTING

INDUSTRIAL TESTING LABORATORY

Report No.: 181207-02B

TEST REPORT

Page 1 of 5

Report Date: 07 January 2019

Project Name: RT3400 W&R 6" Red / 6" White
DOT-C2 Conspicuity Trim

Manufactured by: Reflective Material Co., Ltd. China

Submitted by: Hangzhou Inspire Tech Service
Hangzhou 310018, China

Test Laboratory: Calcoast - ITL
San Leandro, CA 94577

Samples Submitted: Two (2) rolls of alternating 152 mm Red / 152 mm White
50 mm wide conspicuity tape ~4.6 m long each

SUMMARY

Specification: FMVSS-108 / ASTM D4956-90 Type V Sheeting, Class 1 Backing

FMVSS 108 88.2.1

88.2.1.1 Construction	Passed
88.2.1.2 / 88.2.1.4 Pattern/Dimensions	Passed
88.2.1.3 Certification Marking	Passed
88.2.1.7 / Table XVI-c Coefficient of Retroreflection	Passed

ASTM D4956-90

7.3 Daytime Color and Luminance	Passed
7.4 Accelerated Weathering (modified)	Not Tested
7.5 Colorfastness	Not Tested
7.6 Shrinkage	Not Tested
7.7 Flexibility	Not Tested
7.8 Liner Removal	Not Tested
7.9 Adhesion	Passed
7.10 Impact Resistance	Not Tested
7.11 Specular Gloss	Not Tested

Note: Minimum amount of sheeting required to test to ASTM D4956 is four 305 mm x 305 mm sheets.

REFLECTANTE PARA CARROCERIAS

CERTIFICAION DOT-C2

Report No.: 181207-02B

TEST DATA SHEET

Project Name: RT2400 W&R 6" Red / 6" White
DOT-C2 Conspicuity Trim

S8.2.1.1 Construction

Retroreflective sheeting consists of a smooth, flat, transparent exterior film with retroreflective elements embedded or suspended beneath the film so as to form a non-exposed retroreflective optical system.

S8.2.1.2 Pattern / S8.2.1.4.1 Dimensions

Reflective sheeting is made up of alternating white and red color segments of the following dimensions:

Segment	Red	White	Required
Length	152 mm (50.0%)	152 mm (50.0%)	300 ± 150 mm
Width	50 mm	50 mm	50 mm (DOT-C2) 75 mm (DOT-C3) 100 mm (DOT-C4)

Neither white nor red sheeting shall represent more than two thirds (66.7%) of the aggregate of any continuous strip marking the width of a trailer, or any continuous or broken strip marking its length.

Samples meet Pattern/Dimension requirements.

S8.2.1.3 Certification Marking

The letters "DOT-C2" appear at least once on each white or red sheeting segment in characters at least 3 mm high or at least once every 300 mm on sheeting that is white only.

Samples meet Certification Marking requirements.



REFLECTANTE PARA CARROCERIAS

BICOLOR NORMA DOT-C2

Report No.: 181207-02B

TEST DATA SHEET

Project Name: 1 RT3400 W&R 6" Red / 6" White
DOT-C2 Conspicuity Trim

7.3 Daytime Color and Luminance

Requirement: ASTM D4956-90 Tables 8 and 10 (Type V Sheeting)
Test Method: ASTM E308, E1347, E1349, E991, E1164
(Illuminant C, 2° Observer, 45/0 Geometry)
Instrument: Hunterlab Colorflex Spectrocolorimeter (No SCF available)

Color	Sample	x	y	Y		
				Measured	Minimum	Maximum
Red	#1	0.6448	0.3336	10.96	2.5	11
	#2	0.6453	0.3336	10.91		
	#3	0.6444	0.3332	11.00		
White	#1	0.3056	0.3138	42.77	15	-
	#2	0.3060	0.3142	43.45		
	#3	0.3056	0.3138	43.81		

Samples meet Daytime Color and Luminance requirements.

Note: Current ASTM D4956 uses D65 as illuminant instead of C.

Color Plots

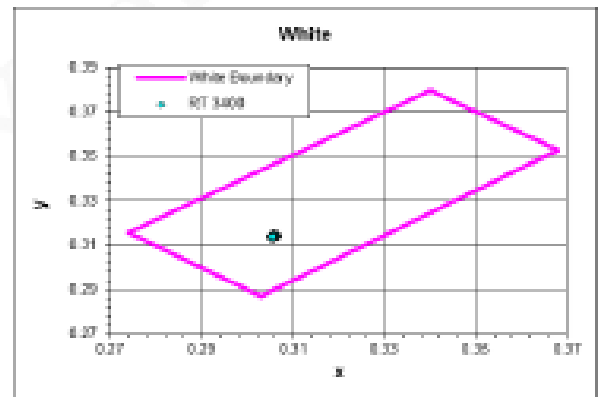
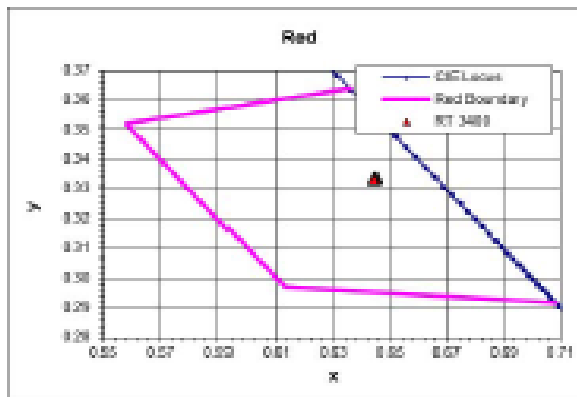

7.9 Adhesion

Requirement: ASTM D4956-90 7.9
Test Method: ASTM D4956-90 8.5

4" each of two (2) 1"x6" sheeting samples were bonded to 0.040" thick degreased and acid-etched 6061-T6 aluminum panels. After conditioning, a 0.79kg weight was hung from the free end of sample 90° to the panel. After 5 minutes, the peel distance was measured.

Product	Peel Distance		Maximum
	1	2	
Red/White	0.35"	1.29"	2.0"

Samples meet Adhesion requirements.

AMPOLLETAS LED MV - SISTEMA CANBUS INCORPORADO

SET (2 AMPOLLETAS)

1301 H1 24V

24 Volts

NUEVO PRODUCTO

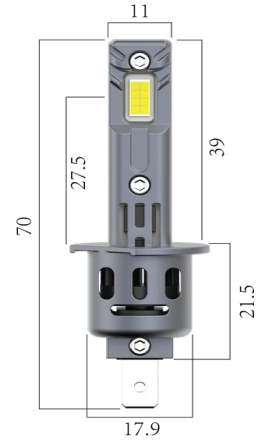

1304 H4 12/24V

Multi Volt

NUEVO PRODUCTO

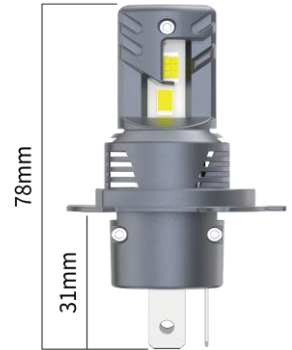

1307 H7 12/24V

Multi Volt

NUEVO PRODUCTO

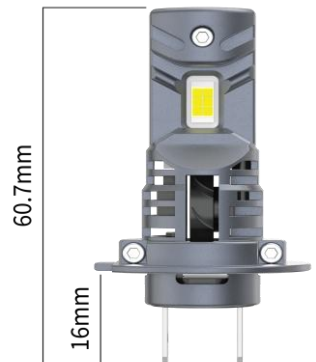

1311 H11 12/24V

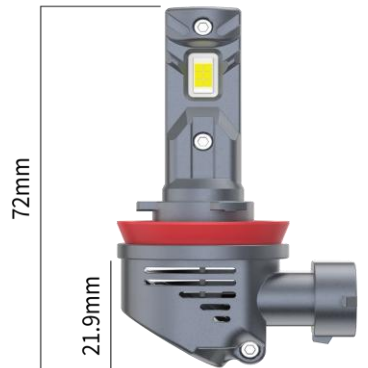

FOCOS LATERALES

LED MV

3056 **ÁMBAR 10 DIODOS MV**

CHINA



3057 **ROJO 14 DIODOS MV**

CHINA



8146 **97 DB 12A 24V**



8130 **CINTA AISLANTE 17 MTS**



CABLES PARA INSTALACIONES ELECTRICAS

ROLLOS

1208 NEGRO 100 MTS

1209 ROJO 100 MTS



CABLE SUPER FLEXIBLE 1,5 mm 750V NEGRO / ROJO CLASE 5 CONFORME A NORMA BRASIL NBR 247

1207 2 X 0,75 100 MTS



8661 CONECTOR PARA CABLE CUADRADO 1207



1210 2 X 1,5 100 MTS



1211 3 X 1,5 100 MTS



1212 4 X 1,5 100 MTS



1213 5X 1,5 100 MTS

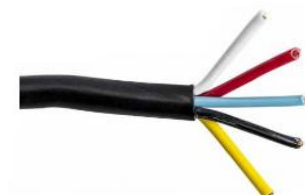

1214 7 X 1,5 100 MTS

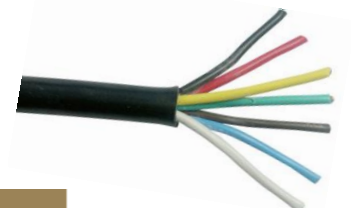

CABLE MULTIVIAS 2, 3,7 VIAS PVC NEGRO -40 + 105°C CLASE 5
CONFORME A NORMA BRASIL NBR 10300

CORRUGADO ABIERTO

ROLLOS

7490	7 mm	25 / 50 MTS
7491	9 mm	25 MTS
7492	10 mm	25 MTS
7493	13 mm	25 / 50 MTS
7494	16 MM	25 MTS
7495	19 mm	25 MTS
7496	22 mm	25 MTS
7497	25 mm	25 MTS
7498	27 mm	25 MTS



AMARRAS PLASTICAS CON FILTRO UV

BOLSA

9030	100 x 2,5 mm	100
9031	150 x 3,5 mm	100
9032	200 x 2,5 mm	100
9034	200 x 4,6 mm	100
9036	300 x 4,6 mm	100
9037	390 x 4,6 mm	100
9039	390 x 7,6 mm	100
9040	750 x 9 mm	100



AMPOLLETAS

9119	H3	12V	55W	VOSLA	
9102	H4	24V	75/70W	VOSLA	
9103	H7	24V	70W	VOSLA	
9121	H7	12V	55W	VOSLA	
9109	24V	W3W		VOSLA	
9126	12V	W3W		VOSLA	
9128	12V	R5W		BA15S	VOSLA
9114	24V	PY21W	AMBAR	BAU15s	VOSLA
9134	12V	PY21W	AMBAR	BAU15s	VOSLA



ENCHUFE HEMBRA Y MACHO TIPO AMERICANO

3304 HEMBRA METAL



3305 MACHO METAL



3306 AMERICANO METAL LARGO 4,5MTS



3301 HEMBRA PLÁSTICO



3302 MACHO PLÁSTICO



3303 AMERICANO PLÁSTICO LARGO 4,5MTS



ENCHUFE HEMBRA Y MACHO TIPO AMERICANO

7338 ENCHUFE HEMBRA 7 POLOS TIPO AMERICANO



7339 ENCHUFE MACHO TIPO AMERICANO CON RESORTE



7340 ESPIRAL 7 POLOS TIPO AMERICANO 3.8 MTS



TAPABARROS - ACCESORIOS

7681 TAPABARRO **MEDIDAS**
1270 x 680 x 680 mm

7680 TAPABARRO **MEDIDAS**
635 x 654 x 137 mm

7682 SOPORTE

7683 PLATINA



		COMPLETO
7681	TAPABARRO	1
7682	SOPORTE	2
7683	PLATINA	4

		COMPLETO
7680	TAPABARRO	1
7682	SOPORTE	1



Di Gilio REAC es el proveedor que los fabricantes de remolques, distribuidores y flotas necesitan, con precios muy competitivos en el mercado y junto a la mejor asesoría técnica, dan solución a los requerimientos de un mercado exigente, junto a esto una ágil logística de distribución, hacen que los productos lleguen justo en el momento en que nuestros clientes lo necesitan en cualquier punto de nuestro país.

La calidad indiscutible de nuestros productos HALDEX garantizan la satisfacción permanente de nuestros clientes. Nuestra política de ventas y asistencia técnica busca siempre solucionar las necesidades reales del usuario, minimizando la posibilidad de generar costos de sobre stocks, hoy en día perjudiciales a la economía de las empresas.



Innovative Vehicle Solutions

- Compresores
- Secadores de aire
- Válvulas
- Componentes electrónicos
- Juegos de reparación y piezas principales

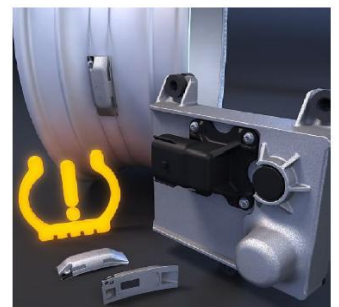

MISIÓN

Brindar a nuestros clientes calidad y rápida respuesta a sus necesidades, acompañándolos en sus proyectos con flexibilidad y experiencia resultado del compromiso y dedicación de nuestra gente, contribuyendo al desarrollo de las personas y garantizando la preservación del medio ambiente.

VISIÓN

Ser la empresa líder en el mercado en la provisión de repuestos de alta calidad y servicio.



COMPONENTES- SET DE HERRAMIENTAS

4186 SET HERRAMIENTAS / REPARACIÓN DE AJUSTADORES AUTOMÁTICOS



4193 CORONA 10 DIENTES PARA AJUSTADOR



4087 CREMALLERA PARA AJUSTADOR AUTOMÁTICO



4086 KIT DE REPARO PARA AJUSTADOR AUTOMÁTICO

AA1



4112 KIT DE REPARO PARA AJUSTADOR AUTOMÁTICO M. BENZ ACTROS / MAN

S-ABA



TIPOS Y APLICACIONES

DE AJUSTADORES AUTOMÁTICOS

AJUSTADOR AUTOMATICO PARA REMOLQUES

4187 10 ESTRIAS

4188 28 ESTRIAS



REGULACION AUTOMATICA

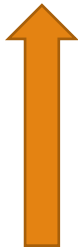

REGULACION AUTOMATICA

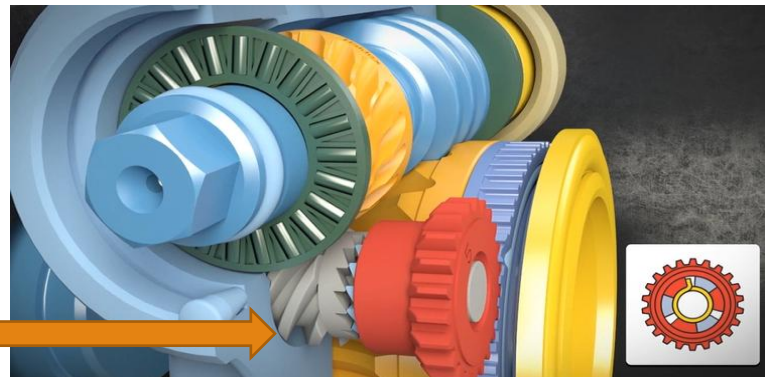

AJUSTADOR AUTOMÁTICOS PARA CAMION

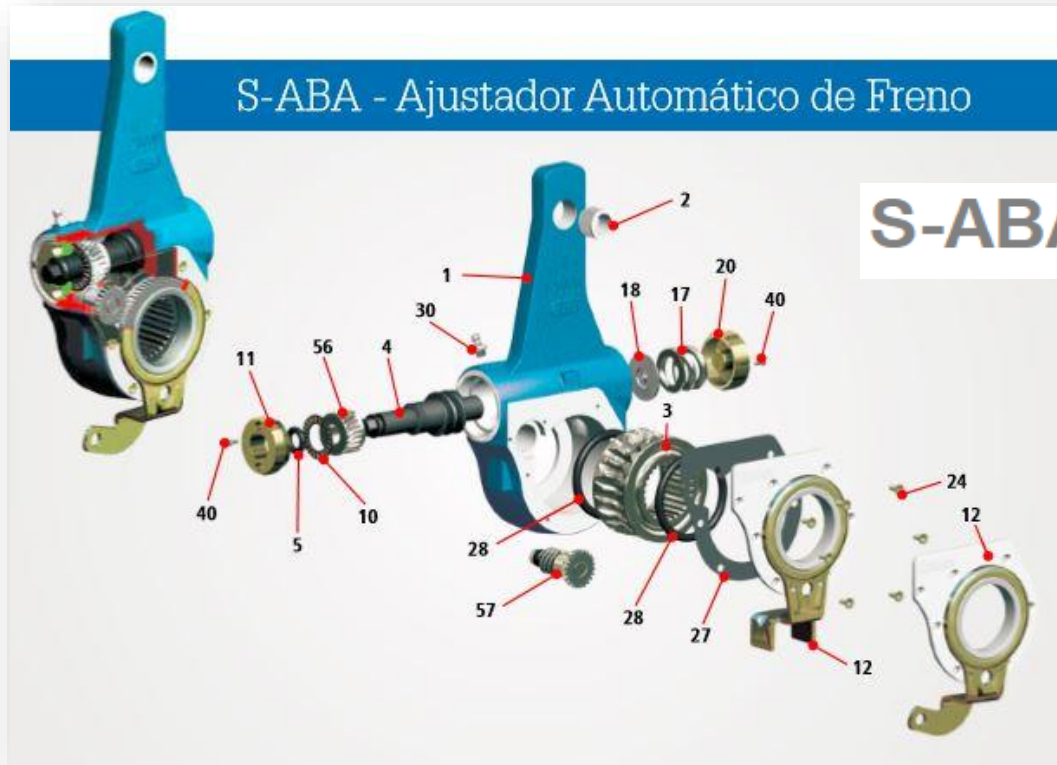

AJUSTADORES AUTOMATICOS AA1

4094	SCANIA	SERIE	P-G-R-T	2003 - 2018
			L-P-G-R-S	2016
		OEM	72807	
		CUERPO	3049	
		SCANIA	2032474	
		POSICION	1	
		U CONTROL	74878SHB	
		LADO	DERECHO	



4095	SCANIA	SERIE	P-G-R-T	2003 - 2018
			L-P-G-R-S	2016
		OEM	72808	
		CUERPO	3050	
		SCANIA	2032475	
		ESTRIAS	10	
		POSICION	1	
		U CONTROL	74878SHB	
		LADO	IZQUIERDO	



4096	SCANIA	SERIE	P-G-R-T	2003 - 2018
			L-P-G-R-S	2016
		BUS	F-K-N	
		OEM	79834	
		CUERPO	4084	
		SCANIA	1789568	
		ESTRIAS	10	
		POSICION	1 - 3	
		U CONTROL	74234SHB	
		LADO	IZQUIERDO	



4093	SCANIA	SERIE	P-G-R-T	2003 - 2018
			L-P-G-R-S	2016
		BUS	F-K-N	
		OEM	79835	
		CUERPO	4083	
		SCANIA	1789567	
			1448121 - 1358634	
		ESTRIAS	10	
		POSICION	1 - 3	
		U CONTROL	74235SHB	
		LADO	DERECHO	



AJUSTADORES AUTOMATICOS

4106	SCANIA	SERIE	P-G-R-T	2003 - 2018
		BUS	F-K-N	
		OEM	79875	
		CUERPO	475-03662	
		SCANIA	2009819	
		ESTRIAS	10	
		POSICION	2	
		U CONTROL	74230SHB	
		LADO	IZQUIERDO	



4109	SCANIA	SERIE	P-G-R-T	2003 - 2018
		BUS	F-K-N	
		OEM	79876	
		CUERPO	475-03663	
		SCANIA	2009820	
		ESTRIAS	10	
		POSICION	2	
		U CONTROL	74230SHB	
		LADO	DERECHO	



AJUSTADORES AUTOMATICOS

4136	M. BENZ	BUS	0500M 4x2 0500R 4x2
			0371 - 0400
		OEM	99600
		CUERPO	3900
		M. BENZ	382 420 0238
			357 420 0538
		ESTRIAS	26
		POSICION	1
		U CONTROL	74686SHB
		LADO	DERECHO - IZQUIERDO



4135	M. BENZ	BUS	0500M 4x2 0500R 4x2
			0371 - 0400
		OEM	99601
		CUERPO	3860
		M. BENZ	382 420 0338
			357 420 0638
		ESTRIAS	26
		POSICION	2
		U CONTROL	74272SHB
		LADO	IZQUIERDO



4137	M. BENZ	BUS	0500M 4x2 0500R 4x2
			0371 - 0400
		OEM	99602
		CUERPO	3861
		M. BENZ	382 420 0438
			357 420 0738
		ESTRIAS	26
		POSICION	3
		U CONTROL	74272SHB
		LADO	DERECHO



4134	M. BENZ	BUS	0500M 4x2 0500R 4x2
			0371 - 0400
		OEM	79911
		CUERPO	4024
		M. BENZ	634 420 0038
		ESTRIAS	26
		POSICION	TRASERA
		U CONTROL	74682SHB
		LADO	DERECHO - IZQUIERDO



AJUSTADORES AUTOMATICOS S-ABA

4114	M. BENZ	CAMION	ACTROS 6x4 3341
			AXOR 4844-3133-3344
		OEM	80683
		CUERPO	5015
		M. BENZ	958 420 0938
		ESTRIAS	26
		POSICION	1
		U CONTROL	74528SHB
	LADO	DERECHO	



4115	M. BENZ	CAMION	ACTROS 6x4 3341
			AXOR 4844-3133-3344
		OEM	80682
		CUERPO	5016
		M. BENZ	958 420 0838
		ESTRIAS	26
		POSICION	1
		U CONTROL	74528SHB
	LADO	IZQUIERDO	



4116	M. BENZ	CAMION	ACTROS 6x4 3341
			AXOR 4844-3133-3344
		OEM	80681
		CUERPO	5017
		M. BENZ	958 420 1138
		ESTRIAS	26
		POSICION	2 - 3
		U CONTROL	74527SHB
	LADO	IZQUIERDO	



4117	M. BENZ	CAMION	ACTROS 6x4 3341
			AXOR 4844-3133-3344
		OEM	80680
		CUERPO	5018
		M. BENZ	958 420 1038
		ESTRIAS	26
		POSICION	2 - 3
		U CONTROL	74527SHB
	LADO	DERECHO	



AJUSTADORES AUTOMATICOS S-ABA

4118	M. BENZ	CAMION	ACTROS 6x4 3341
			AXOR 2040/2540/334
		OEM	80014
		CUERPO	5031
		M. BENZ	945 420 0438
		ESTRIAS	26
		POSICION	3
		U CONTROL	74527SHB
		LADO	IZQUIERO



4119	M. BENZ	CAMION	ACTROS 6x4 3341
			AXOR 2040/2540/334
		OEM	80030
		CUERPO	5018
		M. BENZ	945 420 0938
		ESTRIAS	26
		POSICION	3
		U CONTROL	74527SHB
		LADO	DERECHO



4120	MAN	CAMION	TGX
			28440 29480 - 33440
		OEM	80759
		CUERPO	5019
		M. BENZ	61.50610-6002
		ESTRIAS	26
		POSICION	3
		U CONTROL	74537SHB
		LADO	DERECHO



4121	MAN	CAMION	TGX
			28440 29480 - 33440
		OEM	80758
		CUERPO	5020
		M. BENZ	61.50610-6003
		ESTRIAS	26
		POSICION	3
		U CONTROL	74537SHB
		LADO	IZQUIERDO



AJUSTADORES AUTOMATICOS S-ABA

4140	M. BENZ	CAMION	AROCS
			NEW ACTROS
		OEM	80914
		CUERPO	5015
		M. BENZ	960 420 0638
			961 420 0138
		ESTRIAS	26
		POSICION	1
		U CONTROL	74546SHB
		LADO	DERECHO



4141	M. BENZ	CAMION	AROCS
			NEW ACTROS
		OEM	80915
		CUERPO	5016
		M. BENZ	960 420 0738
			961 420 0038
		ESTRIAS	26
		POSICION	1
		U CONTROL	74547SHB
		LADO	IZQUIERDO



4142	M. BENZ	CAMION	AROCS
			NEW ACTROS
		OEM	80918
		CUERPO	5018
		M. BENZ	961 420 0238
		ESTRIAS	26
		POSICION	2 IZQ
		U CONTROL	74548SHB
		POSICION	3 IZQ - DER



4143	M. BENZ	CAMION	AROCS
			NEW ACTROS
		OEM	80919
		CUERPO	5017
		M. BENZ	960 4200438
			961 420 0338
		ESTRIAS	26
		POSICION	2
		U CONTROL	74549SHB
		LADO	DERECHO



AJUSTADORES AUTOMATICOS S-ABA

4144 M. BENZ

CAMION	AROCS NEW ACTROS
OEM	80917
CUERPO	5031
M. BENZ	961 420 0538
ESTRIAS	26
POSICION	2
U CONTROL	74549SHB
LADO	DERECHO



SENSOR DE DESGASTE DE BALATA

SISTEMA CONSEP SEPARADOR DE AGUA Y ACEITE

DISPOSITIVO CONSEP

- 4081 CONSEP COMPLETO
RELE TEMPORIZADOR / PEDAL FRENO**



KIT DE REPAROS

- 4082 KIT REPARO CICLONE**
- 4084 KIT DE REPARO FILTRO / PISTÓN**
- 4083 VÁLVULA SELENOIDE 24V**



DIAGRAMA INSTALACION - FUNCIONAMIENTO CONSEP

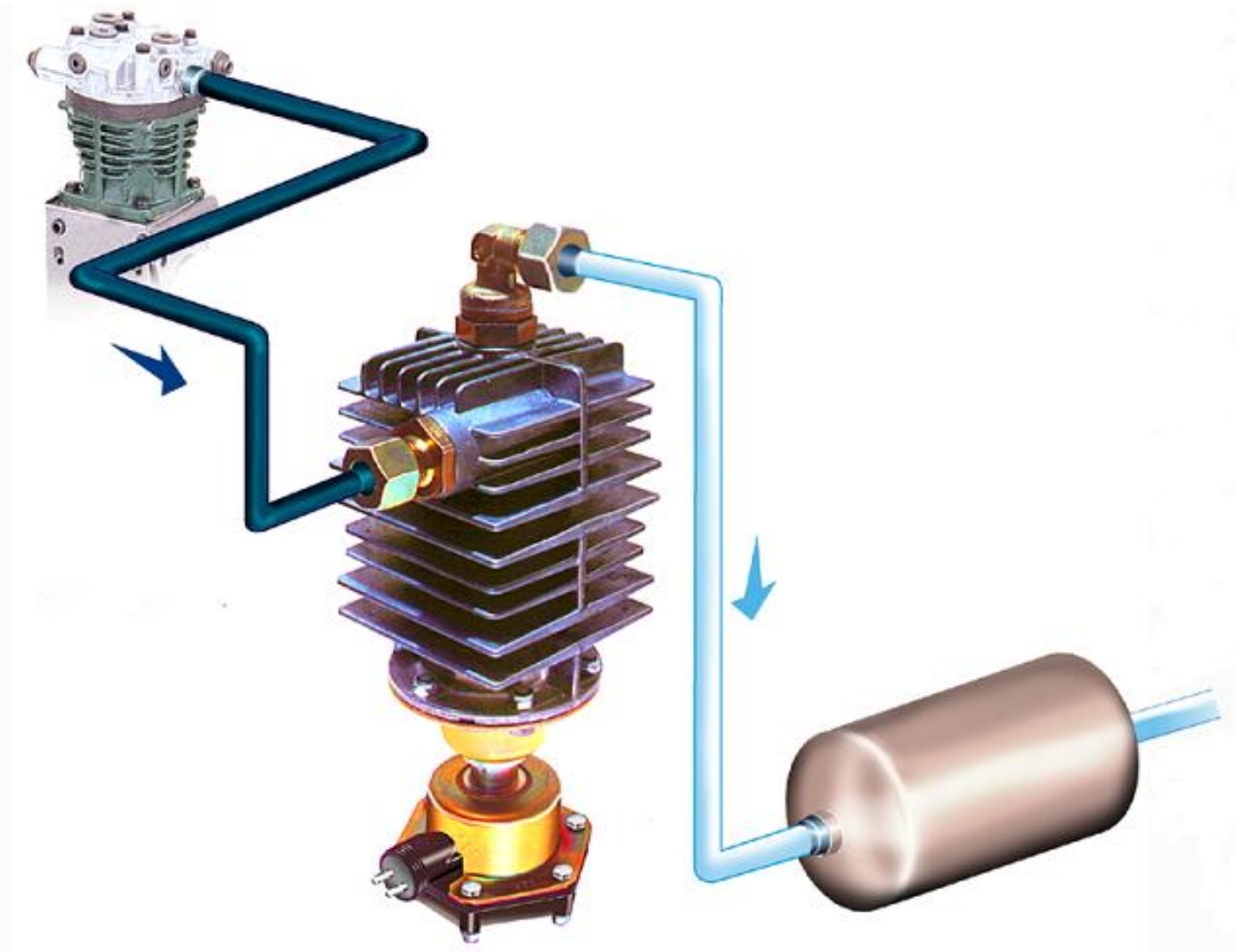

SISTEMA EFICIENTE QUE ELIMINA AGUA Y ACEITE QUE PRODUCE EL COMPRESOR, AYUDA A UNA MAYOR VIDA UTIL DEL FILTRO SECADOR DE AIRE Y SISTEMA NEUMATICO DEL CAMION Y REMOLQUE

FILTRO SECADOR DE AIRE - REPAROS

4100 **FILTRO REPARO**



1697 **SECADOR DE AIRE
APLICACIÓN SCANIA**



1695 **KIT MAYOR
REPARO CAJA REGULADORA
FABRICADAS 2001 EN ADELANTE**



4102 **KIT CON VÁLVULA DE RETENCIÓN
PARA CAJA REGULADORA**



ENCHUFE HEMBRA Y MACHO PARA EBS Y EB + ISO 7638

		ORIGEN	
1730	HEMBRA PLÁSTICO PARA EBS/EB+ ISO 7638	CHINA	
3316	HEMBRA PLÁSTICO PARA EBS/EB+ ISO 7638	BRASIL	
1731	MACHO PLÁSTICO PARA EBS/EB+ ISO 7638	CHINA	
3317	MACHO PLÁSTICO PARA EBS/EB+ ISO 7638	BRASIL	
3310	ESPIRAL C/EXTENSIÓN CAMIÓN AMERICANO PARA ABS/EBS ISO 7638		
1732	ESPIRAL ELÉCTRICO 5,5M PARA ABS/EBS ISO 7638		
1733	ESPIRAL 15 POLOS 7 POLOS 6 POLOS 1 INVERTIDO		
3312	ESPIRAL ELÉCTRICO 5,5M PARA ABS/EBS ISO 7638		

ENCHUFE HEMBRA Y MACHO PARA EBS Y EB + ISO 7638

**3313 ADAPTADOR ISO 7638 Y 24S J560
 PARA CAMION AMERICANO / PIN INVERTIDO**



Adapter ISO 7638 to SAE J560 Auxiliary

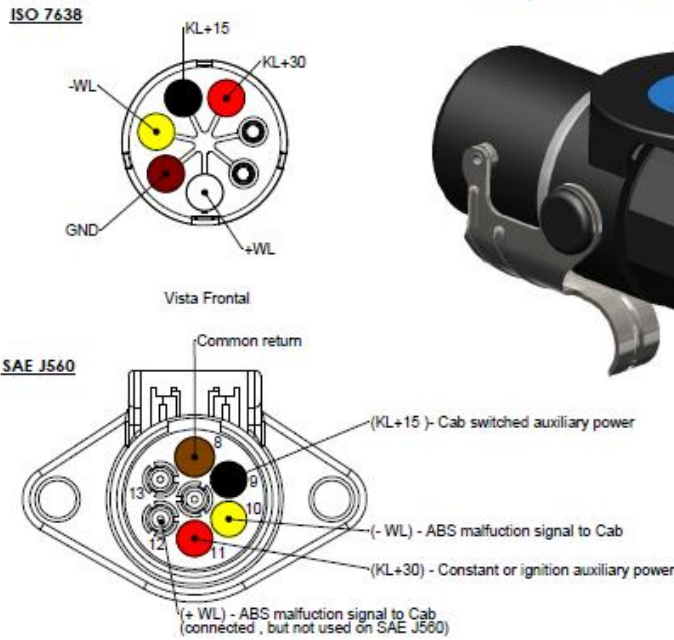

**3315 ENCHUFE HEMBRA 24S J560
 PARA CAMION AMERICANO / PIN INVERTIDO**



SISTEMAS EB+ CONTROL ESTABILIDAD

MODULO STANDARD

1507 EBS 4S/2M GENERACION 3 STANDARD
MV 12 A 24V



1510 CABLE ISO SOCKET 7638 ASSY
12 MTS (POWER A) EBS



1519 CABLE EXTENSION 3 MTS



1520 CABLE EXTENSION 4 MTS



1523 CABLE EXTENSION 8 METROS



1700 SENSOR INLCUYE CLIP



1701 CLIP PARA SENSOR

COMPONENTES PARA CONFIGURACION STANDARD

1702 SENSOR RECTO INLCUYE CLIP



1556 SOPORTE PARA SENSOR ABS / EBS



1705 SOPORTE PARA SENSOR ABS / EBS

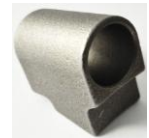

1710 CORONA DE 165 mm 100 DIENTES

1711 CORONA DE 176 mm 100 DIENTES



1525 SOV CABLE VERDE DIAG. DIAG.
PARA DIAGNÓSTICO + / INFO CENTRE
LARGO 6 METROS



1536 VÁLVULA PROTECCIÓN DE PRESIÓN TrCM
HILO M22 x 1,5



REPAROS VALVULA TRCM

1538 REPARO TRCM BOTÓN NEGRO SERVICIO



COMPONENTES PARA SUSPENSION NEUMATICA

SUSPENSION NEUMATICA

4048 VÁLVULA NIVELADORA M12
INCLUYE VARILLA HORIZONTAL



VARILLA HORIZONTAL

4046 VARILLA VERTICAL



4047 PUNTO FIJO PARA INSTALACIÓN



SISTEMAS EB+ CONTROL ESTABILIDAD

1508 VALVULA DOBLE CHECK PARA EBS



1530 EB + GEN 3 LINK CABLE 8 MTS



MODULADORA PARA EJE DISTANCIADO

1504 EB+ GEN 3 1M ESCLAVA 12-24 V



1511 CABLE ISO SOCKET 7638 MACHO 12 MTS (POWER A) EBS



COMPONENTES PARA SISTEMA EBS

1512 CABLE 24N 3 VIAS PARA ABS
(POWER B)



1513 CABLE 12M ISO 1185 (NARANJA)
(POWER B) 814002202



1548 CABLE AUXILIAR OF 7 MTS



8624 FOCO VERDE MV PARA ABS



8632 ENCHUFE



COMPONENTES PARA SISTEMA U-ABS

1506 U-ABS PREMIUM 4S/2M 24V



**1509 CABLE ISO SOCKET 7638 HEMBRA
12 MTS (POWER A) PARA U-ABS**



**1514 CABLE ISO SOCKET 7638 MACHO
16 MTS (POWER A) PARA U-ABS**



1519 CABLE EXT. 3 MTS

1520 CABLE EXT. 4 MTS

1523 CABLE EXT. 8 MTS



1700 SENSOR INLCUYE CLIP



1701 CLIP PARA SENSOR



AUXILIAR SISTEMA U-ABS

1576 TERCERA MODULADORA PARA U-ABS
PARA EJE DISTANCIADO



1577 CABLE 7 MTS PARA TERCERA MODULADORA



PRODUCTOS VARIOS

1501 CONVERTOR DE 24V A 12V 10A



1534 CABLE PARA INFOCENTRE 2



**SE INSTALA EN EL REMOLQUE, ENTREGA
INFORMACION, CODIGOS DE FALLA, PESO TOTAL**

COMPONENTES PARA DIAGNOSTICO

1692 CABLE DIAGNÓSTICO PARA INTERFACE GENERACION 3



1637 CABLE DIAGNOSTICO PARA CONECTAR INTERFACE GENERACION 4

EB+4.0



1690 INTERFACE 011 PARA INFORMACIÓN

1691 INTERFACE 001 PARA PROGRAMACIÓN



1604 CABLE ISO 7638 EB+ DIAGNOSTICO



FUENTE DE PODER

1500 FUENTE DE PODER 220 A 24V



SISTEMA DE DIAGNOSTICO PARA EB S / ABS

1495 MALETA DIAGNOSTICO

**MALETA
CABLE DIAGOSTICO
INTERFACE 011
CABLE USB
PENDRIVE CON PROGRAMA**



1496 MALETA DIAGNOSTICO

**INCLUYE
MALETA
CABLE DIAGOSTICO
INTERFACE 011
INTERFACE 001
FUENTE DE PODER
CABLE USB
PENDRIVE CON PROGRAMA**



SISTEMAS EB+ CONTROL ESTABILIDAD

EB+4.0

- 1607** **MODULO EBS GEN4 4S/2M**

- 1610** **CABLE PODER ISO 7638**

- 1619** **EXTENSION 3 METROS**
- 1621** **EXTENSION 4 METROS**
- 1622** **EXTENSION 6 METROS**

- 1705** **SOPORTE PARA SENSOR ABS / EBS**

- 1710** **CORONA DE 165 mm 100 DIENTES**
- 1711** **CORONA DE 176 mm 100 DIENTES**

- 1640** **CONECTOR PUSH IN PLUG RTC 8 mm**
- 1641** **CONECTOR PUSH IN PLUG RTC 12 mm**

- 1625** **CABLE DIAGNOSTICO**

- 1632** **CABLE POWER B**

- 1635** **CABLE PARA LUZ DE AVISO**

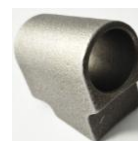

AUXILIARES PARA SISTEMA EBS GEN4

EB+4.0

1648 KIT TPMS PARA GEN4 9 RUEDAS

1666 KIT TPMS PARA GEN4 13 RUEDAS



		KIT 1648	KIT 1666
1660	MODULO TPMS GEN4	1	2
1661	CABLE TPMS	1	1
1662	SENSOR PARA RUEDA	9	13
1663	CORREA PARA SENSOR	9	13
1664	ETIQUETA	9	13
1658	CABLE RCU2 6 mts		1
1659	CABLE Y IPSO		2

1668 TPMS 2.0 SMART BOX



1649 KIT COMPLETO PARA SISTEMA SOFT DOCKING



1659 CABLE IPSO Y
PARA CONECTAR AUXILIARES



AUXILIARES PARA SISTEMA EBS GEN4

EB+4.0

**1639 VALVULA TEM
HILO M22 x 1,5**



**1670 INFOCENTER EB+ NORMA ADR
(SIN BATERIA)**



1671 CABLE PARA INFOCENTRE GEN4

1545 VÁLVULA ILAS-E HILO 4 X M16 X 1,5

1642 CABLE PARA VALVULA ILAS GEN4



VALVULA ILAS - COMANDAR EJE IZABLE - TRABAJA EN FUNCION DE LA CARGA. SI EL REMOLQUE ESTA CARGADO EL EJE ESTE SE MANTIENE ABAJO - DESCARGADO SE MANTIENE ARRIBA

AUXILIARES PARA SISTEMA EBS

1537 VÁLVULA COLAS CON CONEXIONES 8 mm
SELENOIDE 24V 338 071 101

1642 CABLE 4 MTS

**VALVULA COLAS, FUNCION REGULA ALTURA DE SUSPENSION
NEUMATICA: EJEMPLO ANDENES DE CARGA.**

EB+4.0

1541 SENSOR MECÁNICO ALTURA

SUSPENSION MECANICA

1642 CABLE PARA VALVULA ILAS GEN4

4052 VARILLA HORIZONTAL

4046 VARILLA VERTICAL

4047 PUNTO FIJO PARA INSTALACIÓN



COMPONENTES PARA SUSPENSION NEUMATICA

SUSPENSION NEUMATICA

4048 VÁLVULA NIVELADORA M12
INCLUYE VARILLA HORIZONTAL



VARILLA HORIZONTAL



4046 VARILLA VERTICAL



4047 PUNTO FIJO PARA INSTALACIÓN



SISTEMAS TEBS - E CONTROL ESTABILIDAD

**3000 ECU TEBS E PREMIUM
 MV 12 A 24V**



**3008 CABLE ALIMENTACION 7638 MACHO
 10 METROS**



3009 CABLE ALIMENTACION 7638 HEMBRA 12 MTS



3013 CABLE EXTENSION 3 MTS

3014 CABLE EXTENSION 4 MTS

3015 CABLE EXTENSION 8 MTS



1700 SENSOR INLCUYE CLIP



1705 SOPORTE PARA SENSOR ABS / EBS

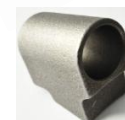

1710 CORONA DE 165 mm 100 DIENTES

1711 CORONA DE 176 mm 100 DIENTES



SISTEMAS TEBS - E CONTROL ESTABILIDAD

3026 CABLE DIAGNOSTICO



3002 SENSOR MECANICO DE ALTURA



3003 VARILLA PARA SENSOR MECANICO



4046 VARILLA VERTICAL



3004 SOPORTE PARA VARILLA



3006 CABLE PARA SENSOR MECANICO



COMPONENTES PARA TEBS - E CONTROL ESTABILIDAD

3011 **ADHESIVO EBS WABCO**

WABCO

EBS

TRAILER

3022 **SENSOR DE PRESION**



3023 **CABLE PARA SENSOR DE PRESION
10 METROS**



3020 **VALVULA RELE MODULADORA EBS
24V**



3021 **CABLE MODULAR TEBS 8 METROS**



3025 **VALVULA PREV**



3032 **VALVULA ROTATIVA M12 x M16**



SMART BOARD - AUXILIAR TEBS

3040 VALVULA LACV



3041 CABLE GIO LACV



3034 PANTALLA SMART BOARD ADR



3035 CABLE



3036 ADAPTADOR



SISTEMA MONITOREO PRESION Y TEMPERATURA - RUEDAS

3075 SOPORTE ECU OPTITIRE / OPTILINK

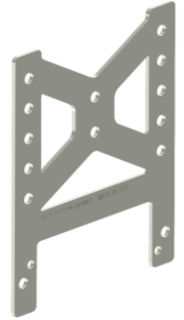

3076 ECU OPTITIRE

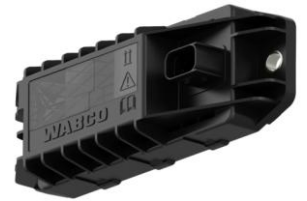

3077 CORREA 22,5 " / OPTITIRE



3078 SENSOR INTERNO /OPTITIRE



3079 CABLE CONEXION OPTITIRE / SMARTBOARD



3064 TPMS MANAGER SCANNER WABCO



SISTEMA MONITOREO PRESION Y TEMPERATURA - RUEDAS

3080 CABLE GIO 5 OPTILINK / OPTITIRE



RECOMENDABLE UTILIZAR SMART BOARD PARA SISTEMA OPTITIRE

3034 PANTALLA SMART BOARD ADR



3035 CABLE



3036 ADAPTADOR



SISTEMA TAIL GUARD - ASISTENCIA AL RETROCESO

3081 CABLE ALIMENTACION ELEX TAIL GUARD



3087 MODULO ELEX TAIL GUARD



3082 SENSOR ULTRASONIDO TAIL GUARD



3083 ALARMA SONORA TAIL GUARD



3084 CABLE EXTENSION
PARA SENSOR TAIL GUARD



SISTEMA TAIL GUARD - ASISTENCIA AL RETROCESO

3085 CABLE DIVISOR
SENSOR TAIL GUARD



3086 CABLE CONEXION
A LUCES TAIL GUARD



MALETA PARA DIAGNOSTICO SISTEMA TEBS

1498 MALETA DIAGNOSTICO TEBS WABCO

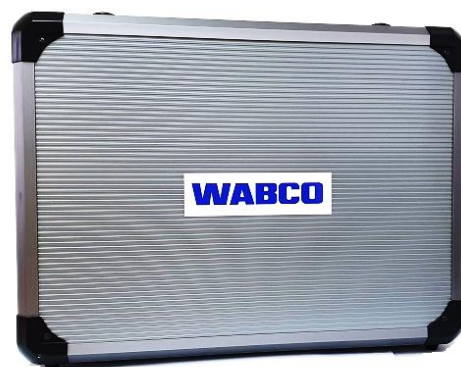

COMPONENTES INCLUIDOS EN MALETA DIAGNOSTICO

3050 CABLE DIAGNOSTICO 7638



3051 CABLE DIAGNOSTICO CAN



3052 INTERFACE PARA DIAGNOSTICO



3053 CABLE DAGNOSTICO LINEA K



KIT ABS 24V 2S/2M

- 3061** KIT COMPLETO ABS WABCO 24V 2S/2M
- 3066** KIT ABS WABCO 24V INCLUYE INSTALACION
- 5283** KIT BASE CONECTORES PARA KIT ABS (FOTOS REFERENCIALES)



KIT ABS INCLUYE:

- | | | |
|-------------|------------------------------|----------|
| 3060 | KIT ABS 2S/2M 24VV | 1 |
| | CABLE PODER ISO 7638 | 1 |
| | EXTENSION CABLE PODER | 1 |
| | EXTENSION DE SENSOR | 2 |
| | ADHESIVOS ABS | |
| 1710 | CORONA DE 165 mm | 2 |
| 1711 | CORONA DE 176 mm | |
| 1700 | SENSOR Y CLIP | 2 |
| 4042 | FILTRO DE LINEA | 1 |
| 8624 | FOCO VERDE PARA ABS | 1 |
| 3062 | CABLE PARA FOCO VERDE | 1 |



- 3063** CABLE DIAGNOSTICO (OPCIONAL)



SISTEMA TPMS PARA SEMIREMOLQUES

MONITOREA PRESION Y TEMPERATURA EN LAS RUEDAS DEL SEMIREMOLQUE

6604 KIT PARA 2 EJES MAS RUEDA REPUESTO (9)

6605 KIT PARA 3 EJES MAS RUEDA REPUESTO (13)

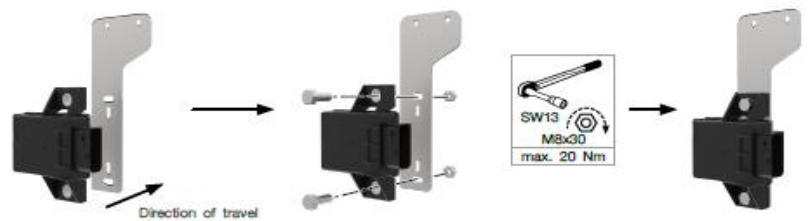

NUEVO PRODUCTO

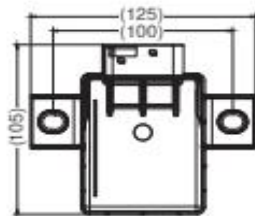
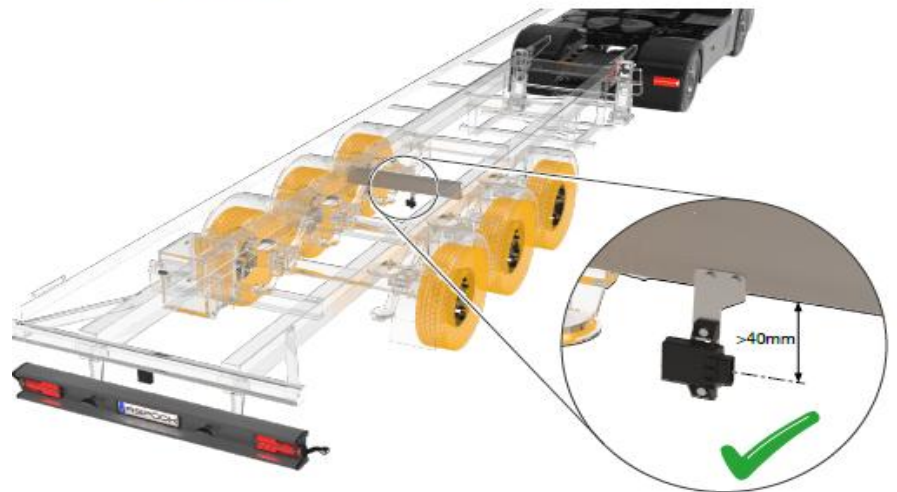

ASPÖCK TPMS RECEIVER MAXRX18

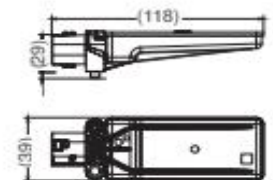

ASPÖCK TPMS SUB - RECEIVER ERX

SISTEMA TPMS PARA SEMIREMOLQUES



HERRAMIENTAS PARA DIAGNOSTICO

6608 DISPOSITIVO CONFIGURACION



6610 PENDRIVE PARA COMPUTADOR



6610 ADAPTADOR

6611 KIT CABLES

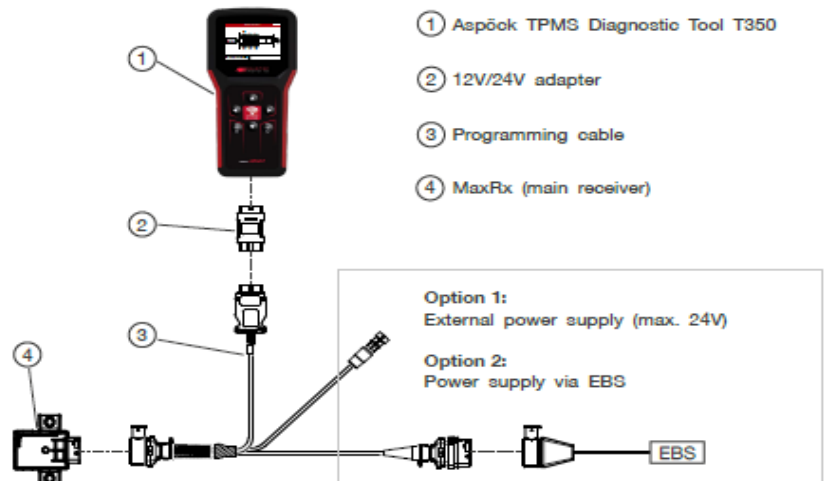

SISTEMA TPMS PARA SEMIREMOLQUES

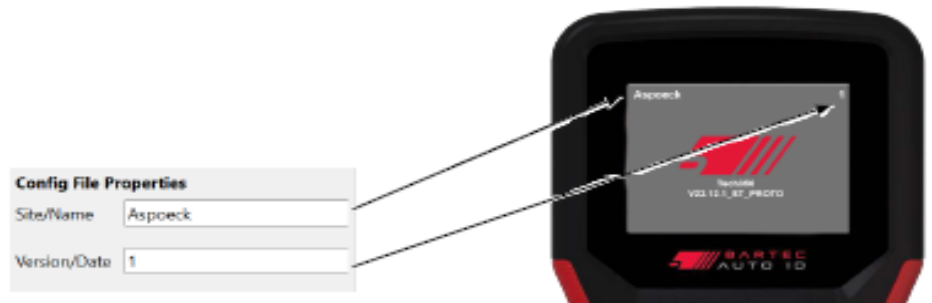
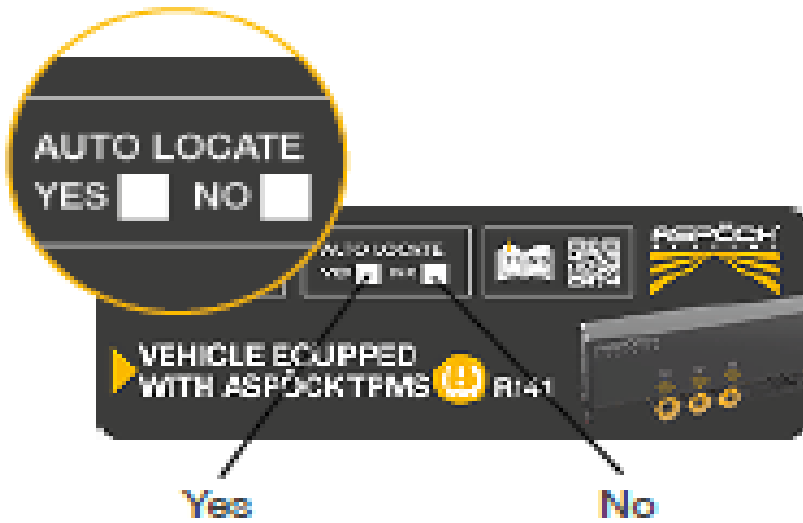

9 Click on Save Config File and select a storage location for the configuration file.

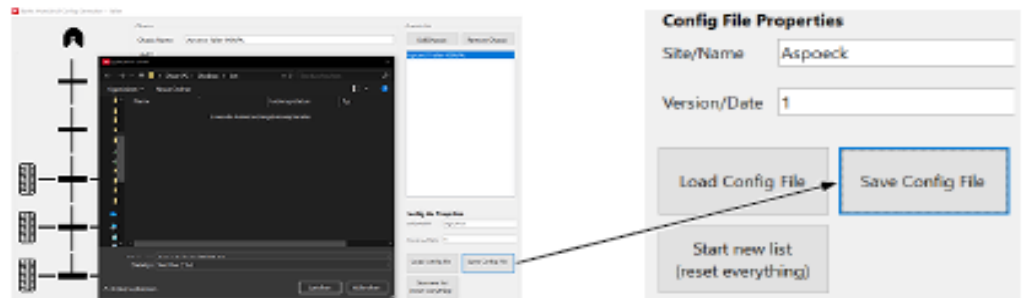

KIT ABS 2S/2M

6540 KIT ABS 2S/SM 24V BASICO

INCLUYE

**MODULO ABS 24V
CABLE DE ALIMENTACION
2 EXTENSIONES**



**6538 CABLE ALIMENTACION
PARA MODULO ABS**



**6539 MODULO ABS 2S/2M 24V
(SOLO MODULO)**



KIT ABS 2S/2M DUAL 12 A 24V

6530 KIT ABS 24V DUAL
 CONVERTOR 12 A 24V



KIT INCLUYE

- | | | |
|-------------|---------------------------------|----------|
| | ABS 2S/2M BREX 24V | 1 |
| | EXTENSION DE SENSOR | 2 |
| | CABLE PODER ISO 7638 | 1 |
| | CONVERTOR CON FOCO VERDE | 1 |
| 1710 | CORONA DE 165 mm / 1 | 2 |
| 1711 | CORONA DE 176 mm | |
| 1700 | SENSOR Y CLIP | 2 |
| 4042 | FILTRO DE LINEA | 1 |
| 3315 | ENCHUFE HEMBRA 24S J560 | 1 |

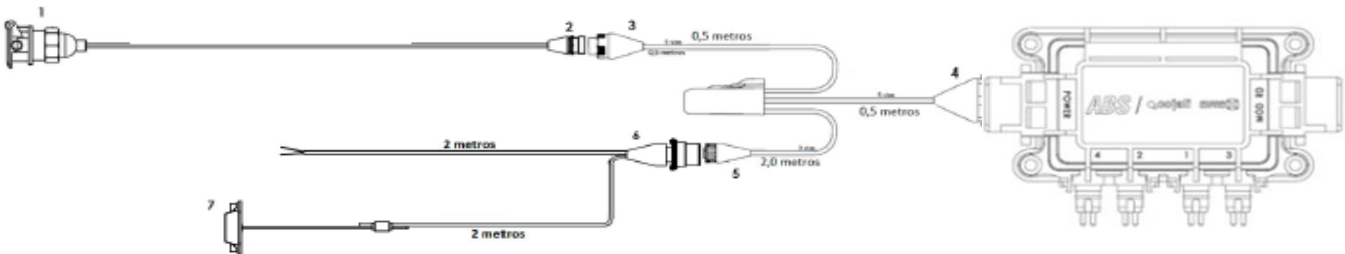

5281 KIT DE CONEXIONES (FOTOS REFERENCIALES)



CONVERSOR DE VOLTAGE 12 A 24V

6545 KIT CONVERSOR 12 A 24V ASPOCK



- + CORRIENTE MAXIMA DE SALIDA 5A
- + TENSION MINIMA DE ENTRADA 9V
- + TENSION MAXIMA DE ENTRADA 65V
- + TENSION DE SALIDA 24V
- + PROTECCION CONTRA INVERSION DE POLARIDAD
- + FUSIBLE PARA PROTECCION DE CORTO CIRCUITO
- + PROTECCION DE SOBRE CORRIENTE
- + PROTECCION CONTRA SOBRE CARGA

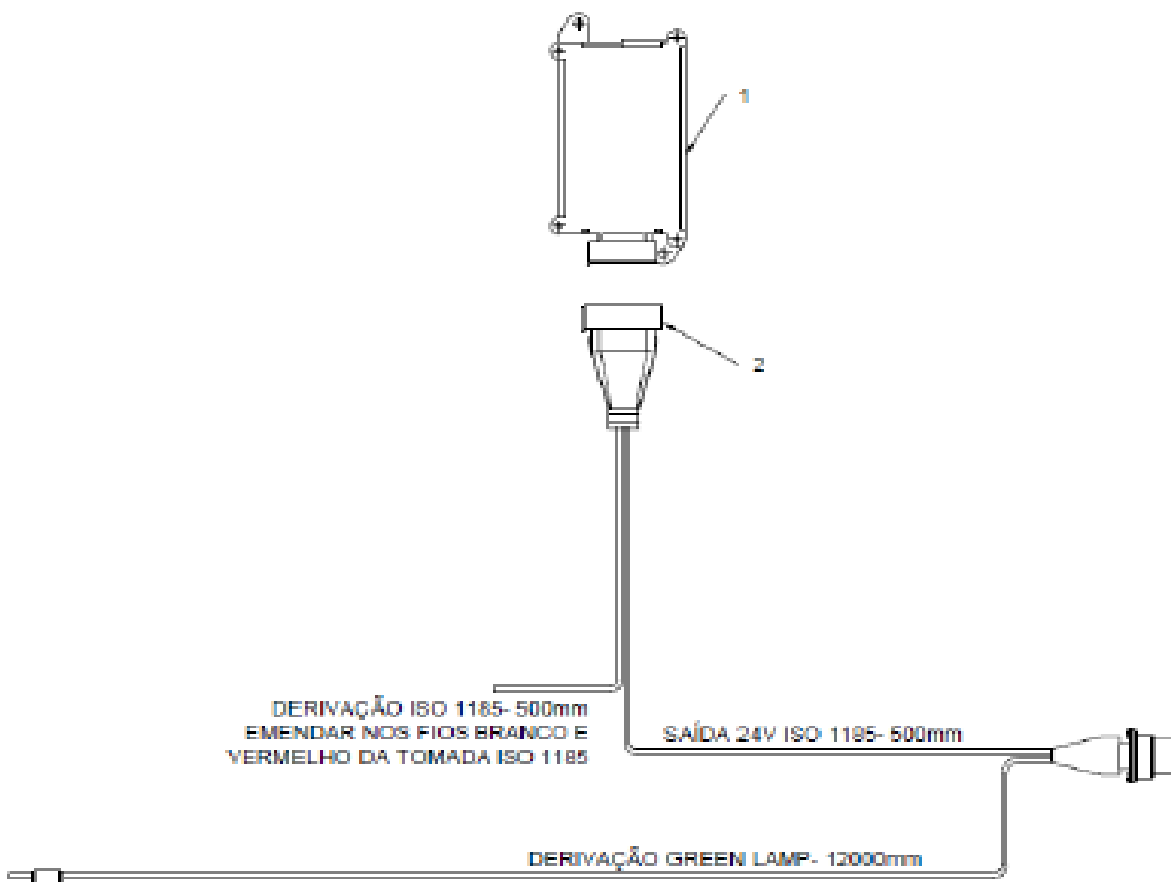

KIT ABS 2S/2M 24V

6531 KIT ABS 24V



KIT INCLUYE

	ABS 2S/2M BREX 24V	1
	EXTENSION DE SENSOR	2
	CABLE PODER ISO 7638	1
1710	CORONA DE 165 mm / 1	2
1711	CORONA DE 176 mm	
1700	SENSOR Y CLIP	2
4042	FILTRO DE LINEA	1



**TOMADA ISO 7638
 ALIMENTAÇÃO DO ABS**

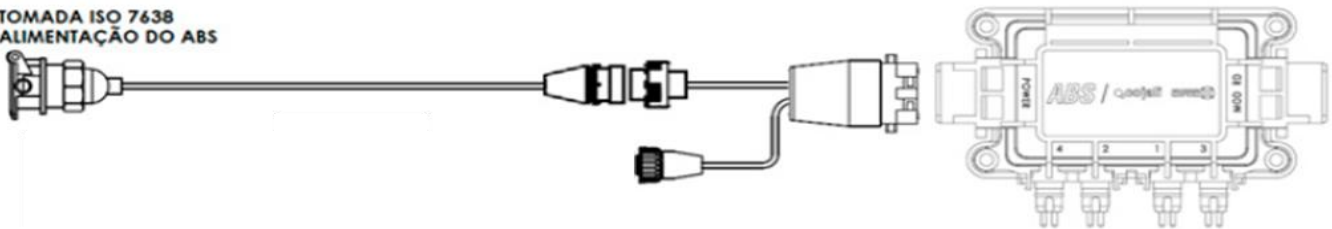

5281 KIT DE CONEXIONES (FOTOS REFERENCIALES)



DISPOSITIVO DIAGNOSTICO ABS BREX

6550 DIAGNOSTICO

Pantalla de inicio:

Muestra la configuración del modelo y del radio de la rueda.



Presione "Confirmar" para abrir la pantalla secundaria.

Pantalla secundaria:

Falla - Confirmar
 se identifican las fallas presentes o no presentes

Role para cima ou para baixo
 para alternar entre as funções possíveis.



Aplicación - Sistema
 el sistema abre la pantalla de diversas funciones.

Falla - Borrar
 elimina los errores que no están presentes.

Menu - Volver

DISPOSITIVO DE DIAGNÓSTICO

CONTROL DE ESTABILIDAD (TS) PARA ABS

LA TRANSICIÓN
MÁS RÁPIDA
PARA CUMPLIR CON
LA LEGISLACIÓN

TS Trailer Stability
para remolques y
semirremolques



ABS+TS
(TRAILER STABILITY)



El módulo TS debe instalarse en el mismo travesaño que el módulo ABS, siguiendo estrictamente la posición indicada en la ilustración, en el mismo lado o en el lado opuesto.

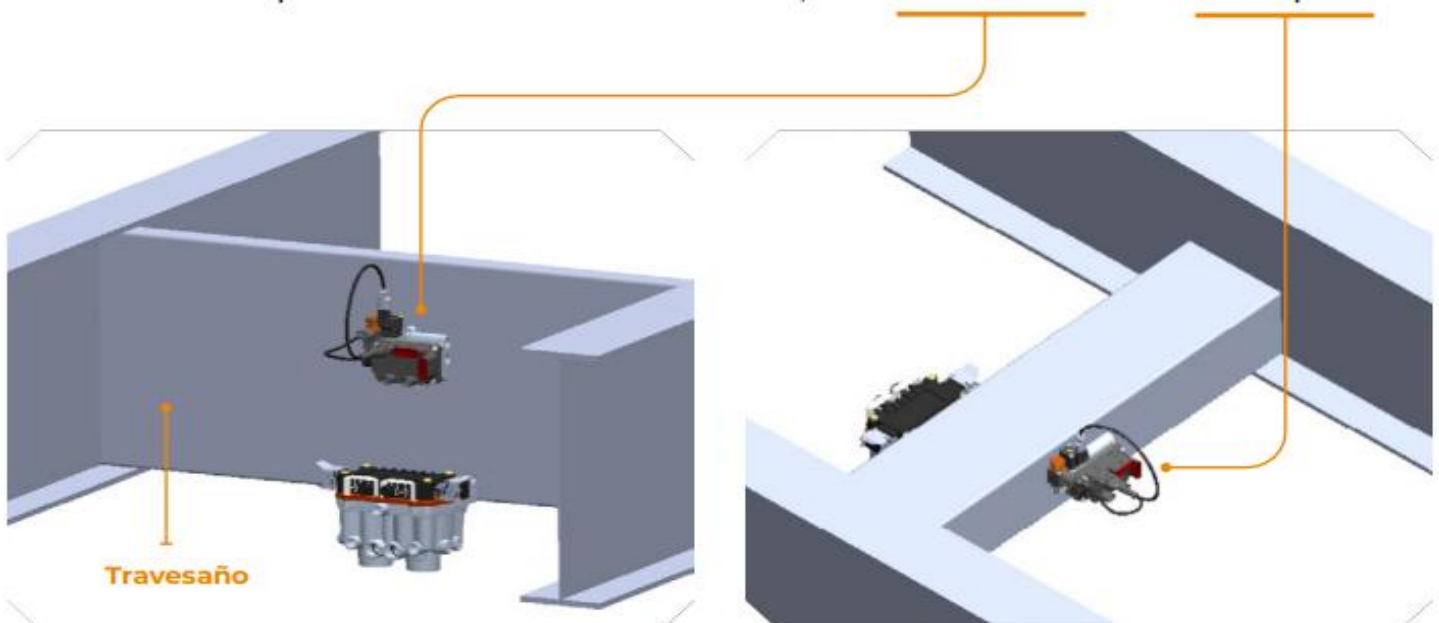

KIT ABS DUAL CON CONTROL DE ESTABILIDAD (TS)

6542 KIT ABS 4S/2M DUAL (12/24V) CONTROL DE ESTABILIDAD TS

INCLUYE

- | | |
|--------------------------------|---|
| KIT ABS | 1 |
| CON CABLE PODER | |
| ENCHUFE AMERICANO Y EUROPEO | 1 |
| MODULO ESTABILIDAD (TS) | 1 |
| CONVERSOR | 1 |
| EXTENSIONES DE SENSOR | 4 |
| SENSORES | 4 |
| CORONA DENTADA (165 o 176 mm) | 4 |
| FILTRO DE LINEA | 1 |
| LAMPARA DE AVISO | 1 |



5281 KIT DE CONEXIONES (FOTOS REFERENCIALES)



MODULO CONTROL DE ESTABILIDAD (TS)

6544 KIT MODULO TS
 CONTROL DE ESTABILIDAD
 SUSPENSION NEUMATICA/MECANICA

INCLUYE CABLES PARA INSTALACION

CONSIDERAR 2 CORONAS Y 2 SENSORES



DIAGRAMA INSTALACION

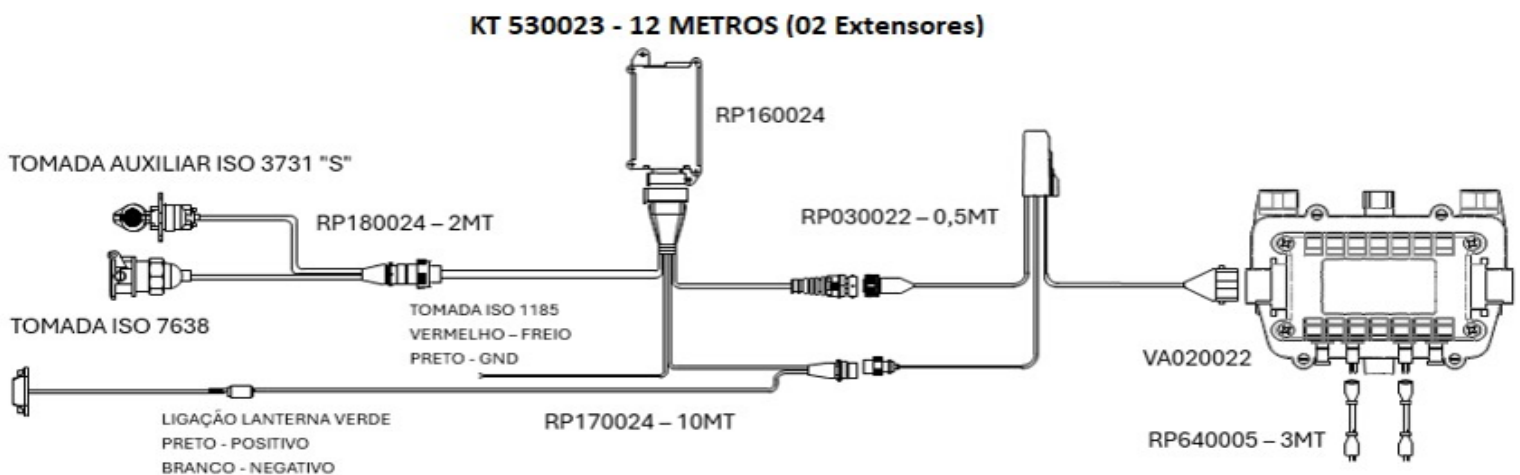

DISPOSITIVO DIAGNOSTICO ABS / TS BREX

6551 SOFTWARE DIAGNOSTICO TS / ABS





REPUESTOS Y ACCESORIOS
PARA CAMIONES Y REMOLQUES

CATALOGO 2026

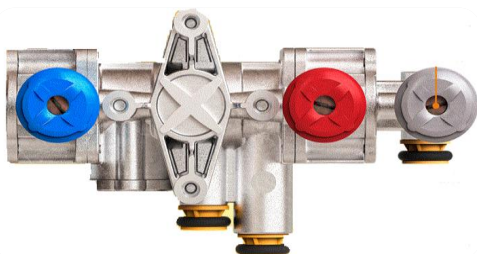

ENERO

VALVULAS DIVERSAS

6536 M16 M16 M16

6537 M16 M22 M16



6502 VALVULA DESCARGA RAPIDA
CON FUNCION DE BLOQUEO
M16 x 1,5 mm
M22 x 1,5 mm



6501 VALVULA RELE
M16 x 1,5 mm
M22 x 1,5 mm



6503 VALVULA NIVELADORA
M12 x 1,5 mm



6510 REPARACIÓN DE PUNTO FIJO



VALVULAS DIVERSAS

6500 VALVULA RELE EMERGENCIA 4 SALIDAS
M16 x 1,5 mm
M22 x 1,5 mm



6546 FRENO DE ESTACIONAMIENTO
HILO M16



6544 VÁLVULA ACCIONAMIENTO
FRENO DE EMERGENCIA
EJE DE LEVANTE HILO M16

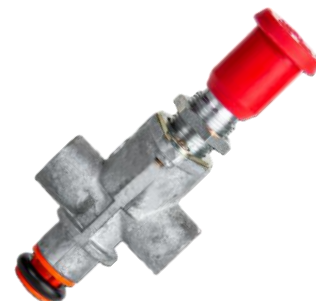

6545 VÁLVULA ACCIONAMIENTO
FRENO DE SERVICIO HILO M16



VALVULAS DIVERSAS

6515 VALVULA MANIFOLD 4 SALIDAS M16 x 1,5 mm



6516 VALVULA REGULADORA DE FLUJO M16 x 1,5 mm



6508 VÁLVULA 2/2 VIAS M16



6509 VÁLVULA 3/2 VIAS M 16



6512 FILTRO DE LINEA M22



VALVULAS DIVERSAS

6504 SIMPLE M16 ROJO
EMERGENCIA



6505 SIMPLE M16 AMARILLA
SERVICIO



6506 AUTOMATICA M16 ROJO
EMERGENCIA



6507 AUTOMATICA M16 AMARILLA
SERVICIO



VALVULAS DIVERSAS

6530 3/2 VIAS CUERPO DOBLE HILO M16



6534 DOBLE RETENCION M16



6513 VALVULA REGULADORA DE PRESION 1/4" CON MANOMETRO



6514 VALVULA REGULADORA DE PRESION 1/4"



6518 PANEL CONTROL 2 REGULADORES PARA TECALAN 8 mm



VALVULAS DIVERSAS

6540 PANEL MULTIFUNCION GENERACION 6

SUSPENSION MECANICA
3 EJES 1 IZABLE

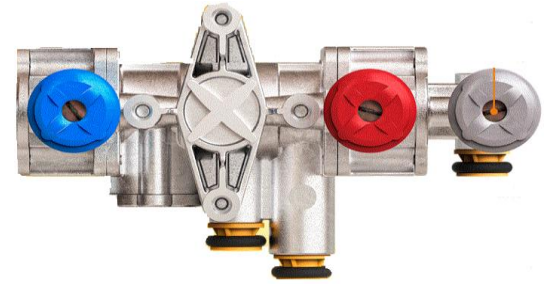

6541 PANEL MULTIFUNCION GENERACION 6

SUSPENSION NEUMATICA
3 EJES 1 IZABLE

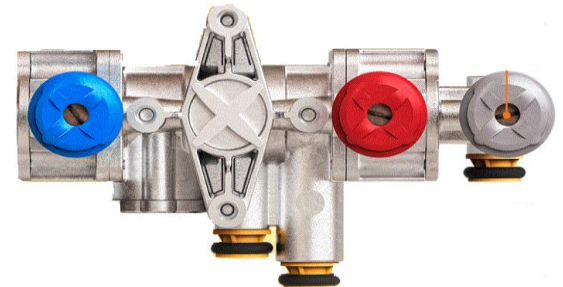

6542 PANEL MULTIFUNCION GENERACION 6

SUSPENSION NEUMATICA
3 EJES 2 IZABLES

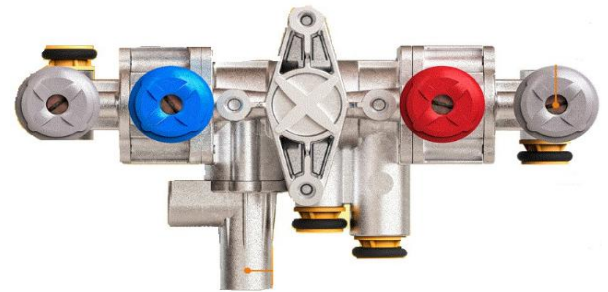

NUEVO PRODUCTO

6519 PANEL MULTIFUNCION 4 GENERACION
3 VALVULAS M16 x 1,5 mm



6520 PANEL MULTIFUNCION 4 GENERACION
2 VALVULAS M16 x 1,5 mm



VALVULAS DIVERSAS

6524 KIT REPARO PANEL MULTIFUNCIONAL



6525 KIT REPARO PANEL MULTIFUNCIONAL



6521 PANEL MULTIFUNCION 3 GENERACION
3 VALVULAS M16 x 1,5 mm



6522 CONJUNTO SOPORTE Y TAPA
2 VALVULAS



6523 CONJUNTO SOPORTE Y TAPA
3 VALVULAS



INCLINOMETRO PARA TOLVAS - BATEAS

VENTAJAS

- ➔ REDUCE RIESGO DE VUELCO
- ➔ PROTEGE LA CARGA Y ESTRUCTURA DEL VEHICULO
- ➔ PROTEGE EL CILINDRO HIDRAULICO
- ➔ PROTEGE AL OPERADOR Y PERSONAS CERCANAS
- ➔ IMPORTANTE SISTEMA DE SEGURIDAD



CARACTERISTICAS Y ESPECIFICACIONES TECNICAS

- ➔ CONTRASEÑA PARA PROGRAMACION Y CONFIGURACION
- ➔ INCLINACIONES LATERALES Y FRONTALES AJUSTABLES DE 0 A 45 GRADOS
- ➔ REGISTRA LOS ULTIMOS 8.000 EVETOS DE RIESGO CON FECHA Y HORA
- ➔ ALIMENTACION DE 8V A 36V
- ➔ GRADO DE PROTECCION DEL SENSOR IP67 (RESISTENTE AL AGUA)



INCLINOMETRO PARA TOLVAS - BATEAS

3201 KIT INCLINOMETRO PARA TOLVAS SISTEMA INALAMBRICO



COMPONENTES



**SENSOR DE INCLINACION
MIDE ANGULOS FRONTALES Y LATERALES**



CENTRAL DE ALIMENTACION



SENSOR DE TOMA DE FUERZA

CABLES



PANEL



VALVULA DE BLOQUEO

INCLINOMETRO INALAMBRICO

3200 KIT INCLINOMETRO PARA BATEAS SISTEMA INALAMBRICO



COMPONENTES

